

10

# Cardio Vascular Surgery

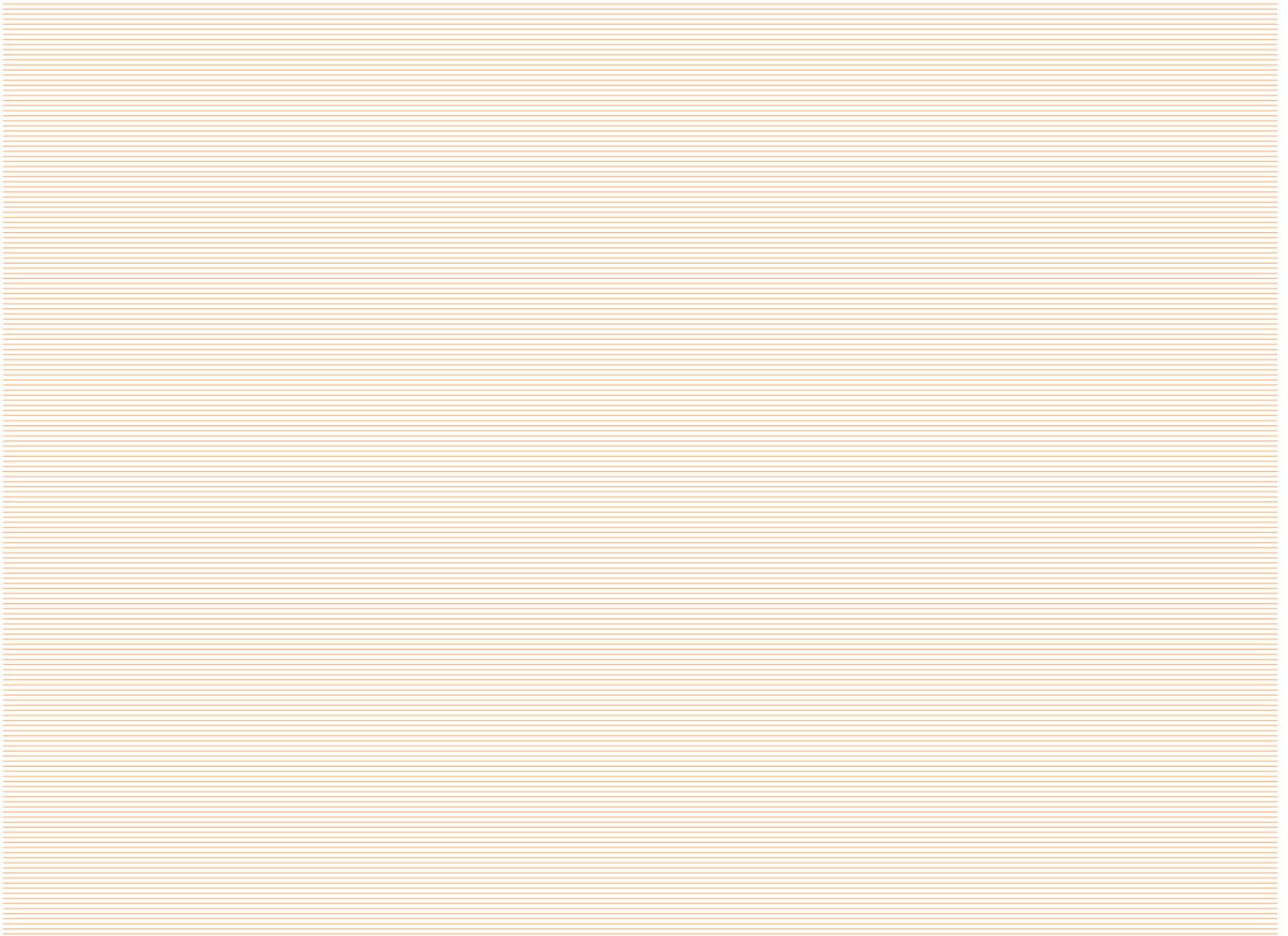

Micro Bulldog Clamps

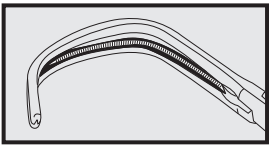

Diethrich

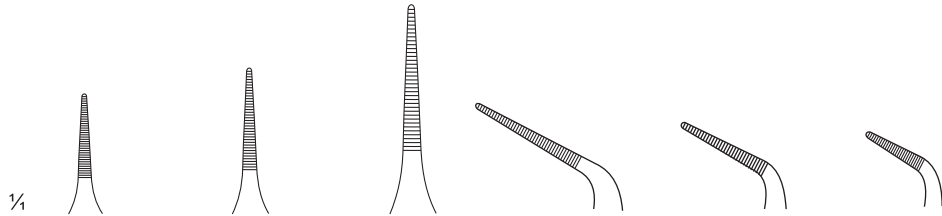

	DC10-001-49	DC10-001-53	DC10-001-59	DC10-003-43	DC10-003-45	DC10-003-50
Length	49mm	53mm	59mm	43mm	45mm	50mm
Jaws	8mm	12mm	20mm	8mm	12mm	20mm
Weight	3 gr.	3 gr.	3 gr.	3 gr.	3 gr.	3 gr.
Pressure	80 gr.	80 gr.	80 gr.	80 gr.	80 gr.	80 gr.

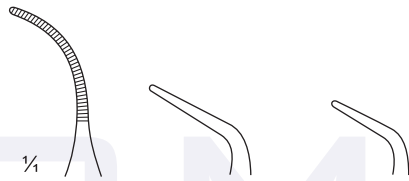

	DC10-005-54	DC10-007-43	DC10-007-49
Length	54mm	43mm	49mm
Jaws	20mm	13mm	18mm
Weight	3 gr.	3 gr.	3 gr.
Pressure	80 gr.	80 gr.	80 gr.



DeBakey

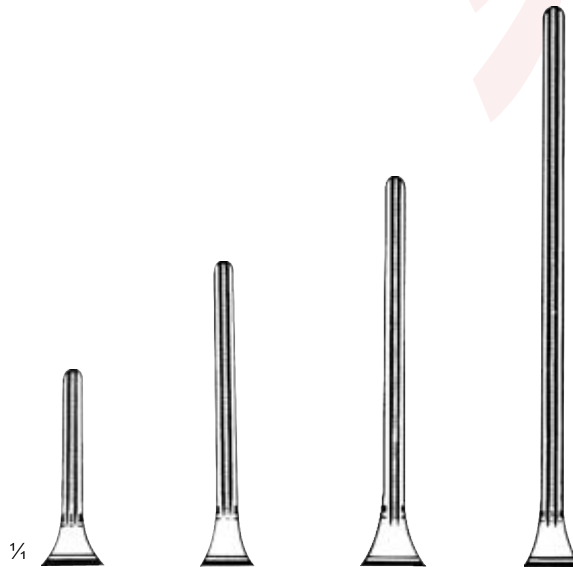

	DC10-009-08	DC10-009-09	DC10-009-10	DC10-009-12
Overall Length	80mm	90mm	105mm	125mm
Jaw Length	20mm	30mm	45mm	68mm
Weight	10 gr.	11 gr.	12 gr.	14 gr.

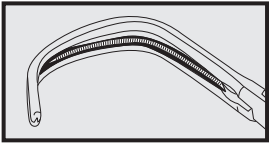

DeBakey

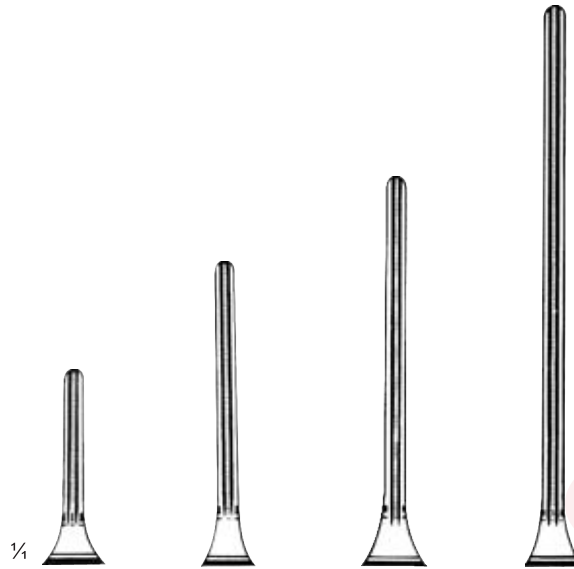

	DC10-011-08	DC10-011-09	DC10-011-10	DC10-011-12
Overall Length	75mm	85mm	95mm	115mm
Jaw Length	20mm	30mm	45mm	68mm
Weight	10 gr.	11 gr.	12 gr.	14 gr.

ACMA INTERNATIONAL

Gregory "Soft" Carotid Bulldog Clamps



	DC10-013-08	DC10-013-11	DC10-013-10	DC10-013-11
Overall Length	90mm	110mm	105mm	110mm
Jaw Length	27mm	44mm	55mm	
Weight	11 gr.	12 gr.	12 gr.	12 gr.

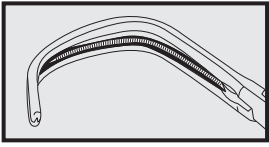

Modifizierte Gregory " Soft "Bulldogklemmen

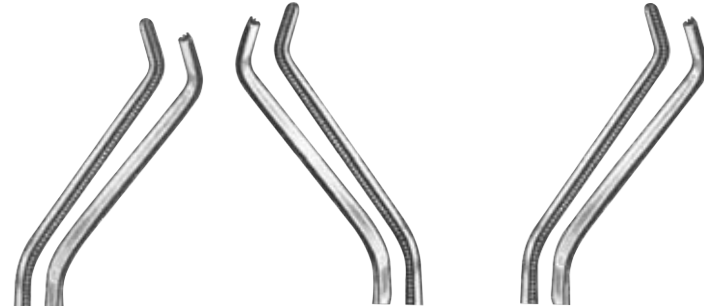

● bent to left

● bent to right

DC10-015-12

DC10-015-13

Overall length	Jaw length	Weight
110mm	60mm	12 g

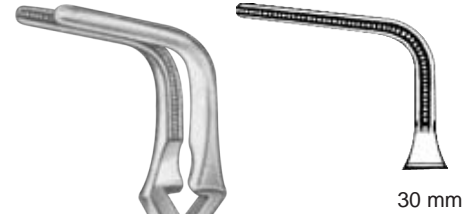

30 mm

¼

**Santulli**  
DC10-017-70  
7cm/2¾"

ACMA  
INTERNATIONAL



Glover

¼

	DC10-019-05	DC10-019-07	DC10-019-09	DC10-019-11
Overall Length	50mm	68mm	85mm	105mm
Jaw Length	20mm	30mm	43mm	56mm
Weight	5 gr.	9 gr.	12 gr.	14 gr.

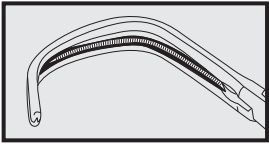

Closing pressure adjustable



Glover

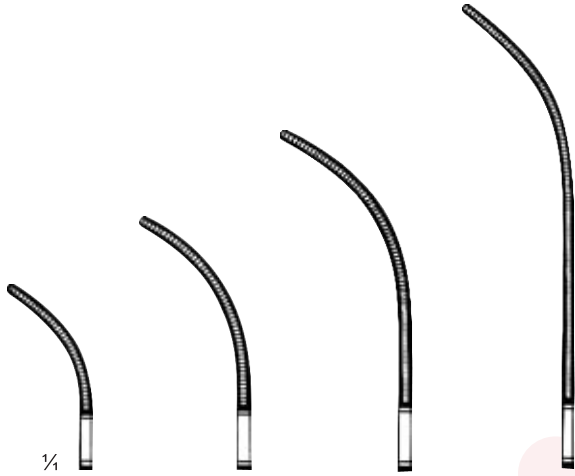

	DC10-021-05	DC10-021-07	DC10-021-08	DC10-021.10
Overall Length	46mm	64mm	78mm	100mm
Jaw Length	20mm	30mm	43mm	56mm
Weight	5 gr.	9 gr.	12 gr.	14 gr.

ACMA  
INTERNATIONAL

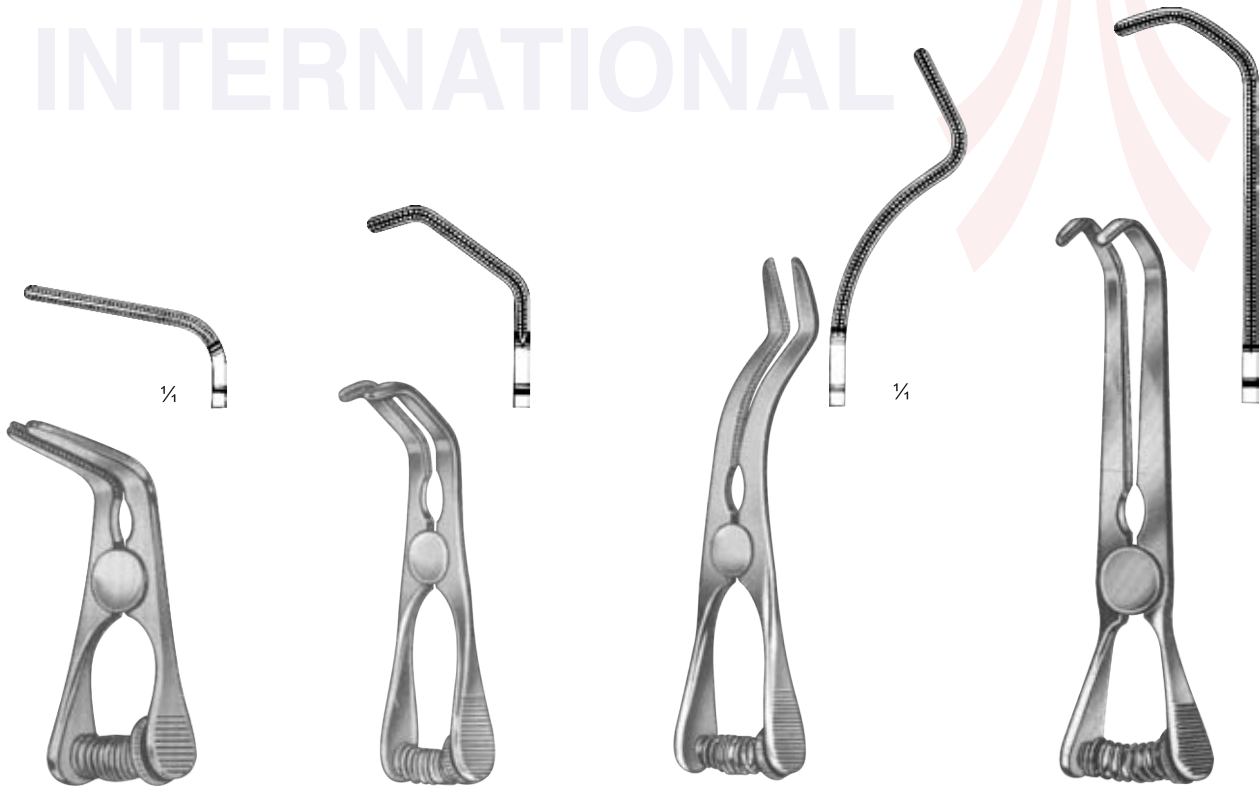

**Glover**  
55mm  
DC10-023-55

**DeBakey-Satinsky**  
55mm DC10-025-55  
65mm DC10-027-65

**DeBakey-Carotid**  
90mm  
DC10-027-90

**DeBakey-Satinsky**  
100mm  
DC10-027-99

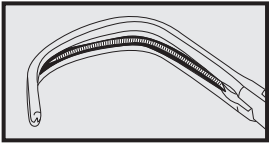

Micro Bulldog Clamps

Micro Bulldog Clamps



DeBakey-Diethrich

	DC10-029-47	DC10-029-51	DC10-029-57	DC10-031-44	DC10-031-46	DC10-031-49	DC10-031-54
Overall Length	47mm	51mm	57mm	44mm	46mm	49mm	54mm
Jaw Length	10mm	14mm	20mm	10mm	14mm	20mm	20mm
Weight	3 gr.	3 gr.	3 gr.	3 gr.	3 gr.	3 gr.	3 gr.
Pressure	180 gr.	180 gr.	180 gr.	180 gr.	180 gr.	180 gr.	180 gr.

Applying Forceps for Bulldog Clamps

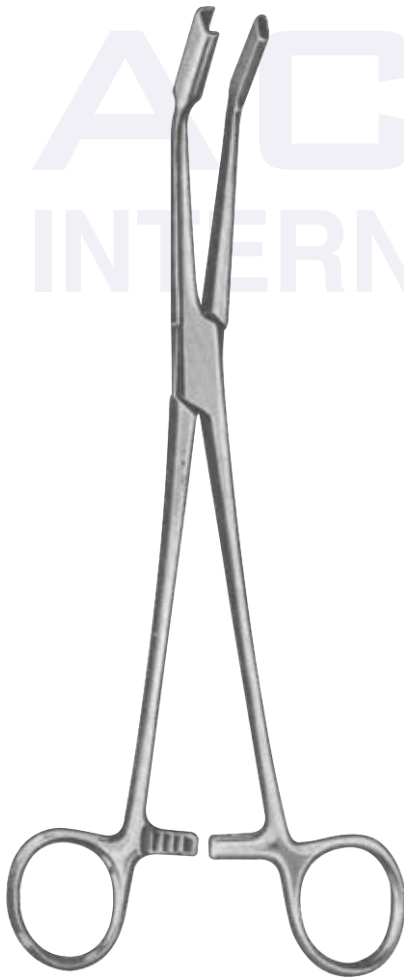

**Johns-Hopkins**  
DC10-033-23  
23cm/9"

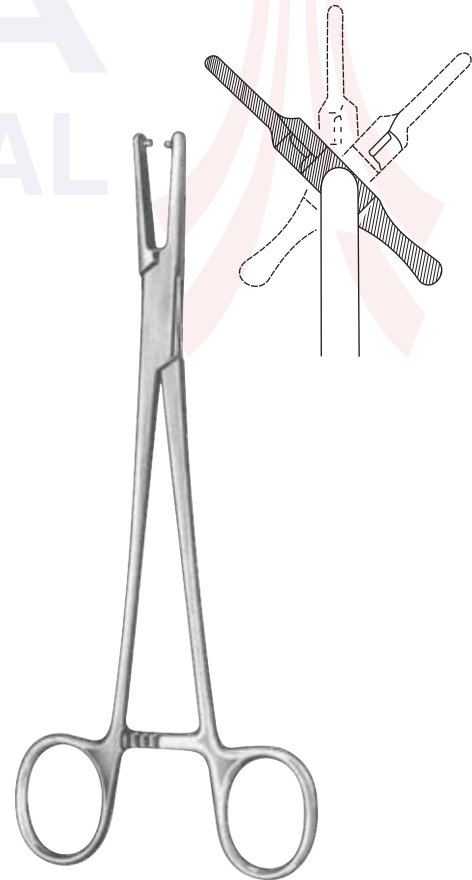
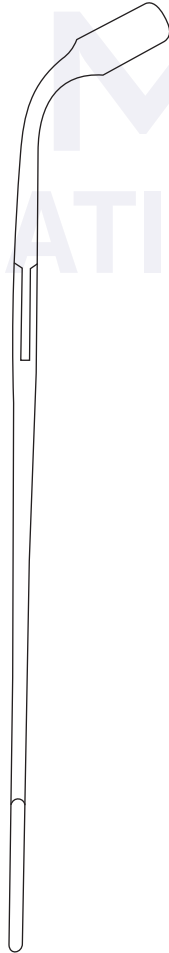

**Wickham**  
DC10-035-24  
24cm/9 1/2"  
Applying forceps for  
Bulldog Clamps Wickham Mini

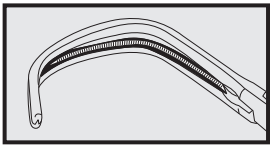

Mini Bulldog Clamps



	DC10-037-49	DC10-037-54	DC10-037-61	DC10-039-47	DC10-039-51	DC10-039-55
Overall Length	49mm	54mm	61mm	47mm	51mm	55mm
Jaw Length	13mm	18mm	25mm	13mm	18mm	25mm

Wickham Mini

DC10-041-00

DC10-041-01

DC10-041-02

DC10-041-03

DC10-045-38

DC10-047-38

DC10-045-51

DC10-047-51

DC10-045-60

DC10-047-60

Mini-Glover (Weldon)

Dieffenbach

Overall length (mm)	Jaw length (mm)	Weight (g)
35	14	12

	DC10-051-31	DC10-051-35	DC10-051-39	DC10-051-30	DC10-051-33	DC10-051-36
Length	31mm	35mm	39mm	30mm	33mm	36mm
Jaws	10mm	14mm	18mm	14mm	14mm	18mm
Weight	1gr.	1gr.	1gr.	1gr.	1gr.	1gr.
Pressure	30gr.	30gr.	30gr.	30gr.	30gr.	30gr.

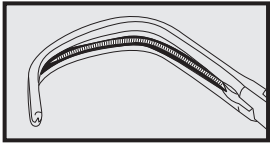

Lung Grasping Forceps, Blood Vessel Clamps



**Derra**  
DC10-053-24  
24 cm/9 1/2"

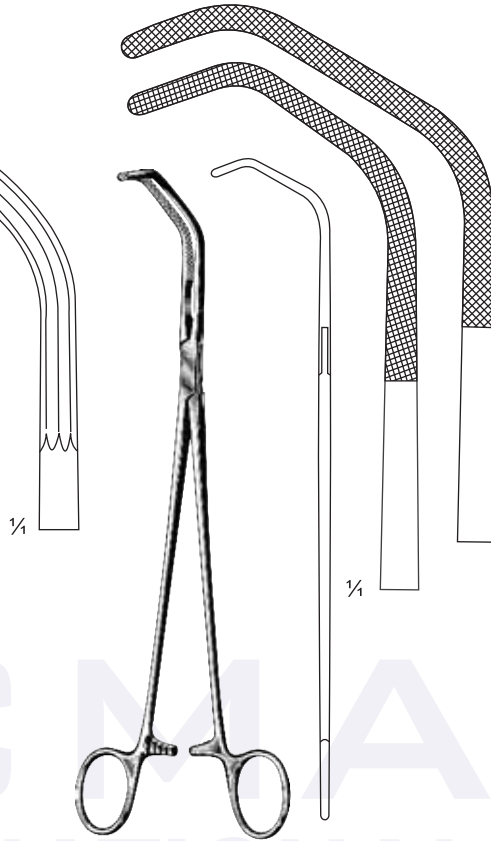

**Satinsky**  
DC10-055-26 = Fig. 1  
DC10-057-26 = Fig. 2  
26.5 cm/10 1/2"

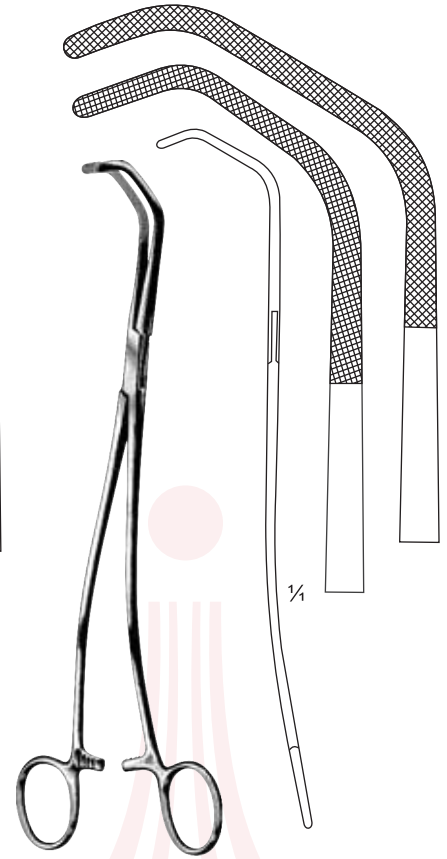

**Satinsky**  
DC10-059-26 = Fig. 1  
DC10-061-26 = Fig. 2  
26.5 cm/10 1/2"

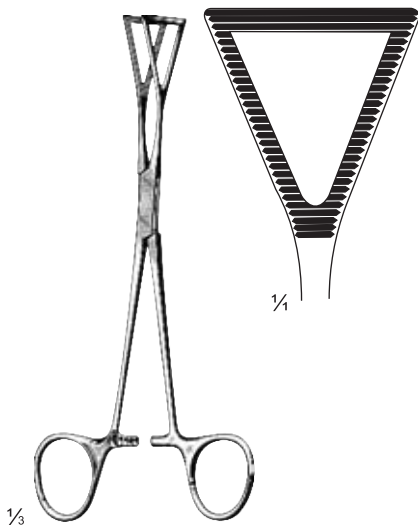

**Lovelace**  
DC10-063-20  
20 cm/8"



**Lovelace**  
DC10-065-20  
20 cm/8"



**Johns Hopkins**  
22 cm/8 3/4"

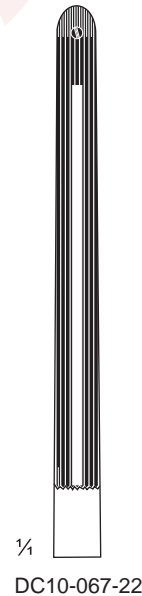

DC10-067-22

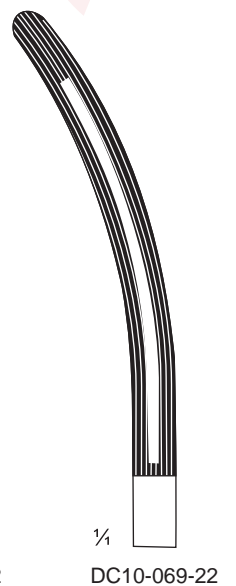

DC10-069-22



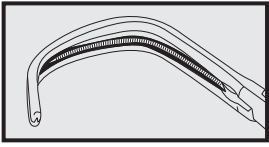

$\frac{1}{2}$   
**Derra**  
DC10-071-18 - DC10-081-18  
18 cm/7"



$\frac{1}{4}$   
DC10-071-18



$\frac{1}{4}$   
DC10-073-18



$\frac{1}{4}$   
DC10-075-18

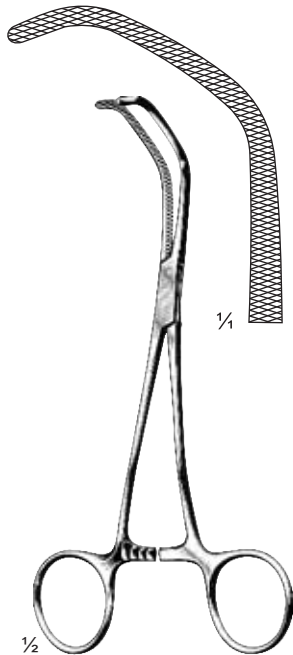

$\frac{1}{2}$   
**Baby-Satinsky**  
DC10-077-15  
15 cm/6"

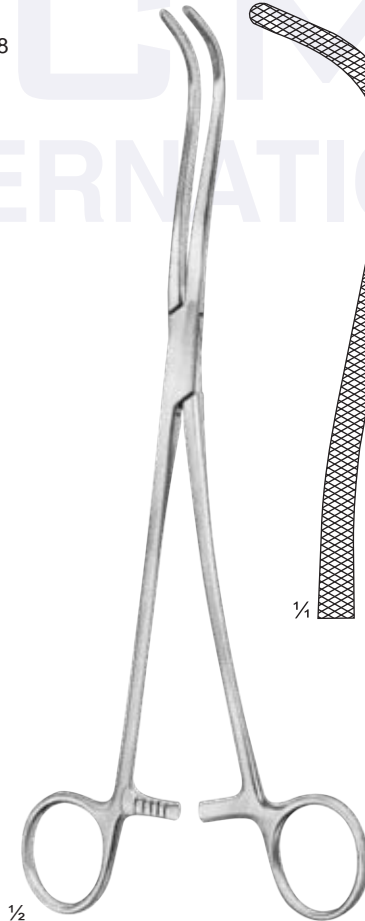

$\frac{1}{2}$   
**Harken**  
DC10-079-24  
24 cm/9  $\frac{1}{2}$ "



$\frac{1}{2}$   
**Harken**  
24 cm/9  $\frac{1}{2}$ "

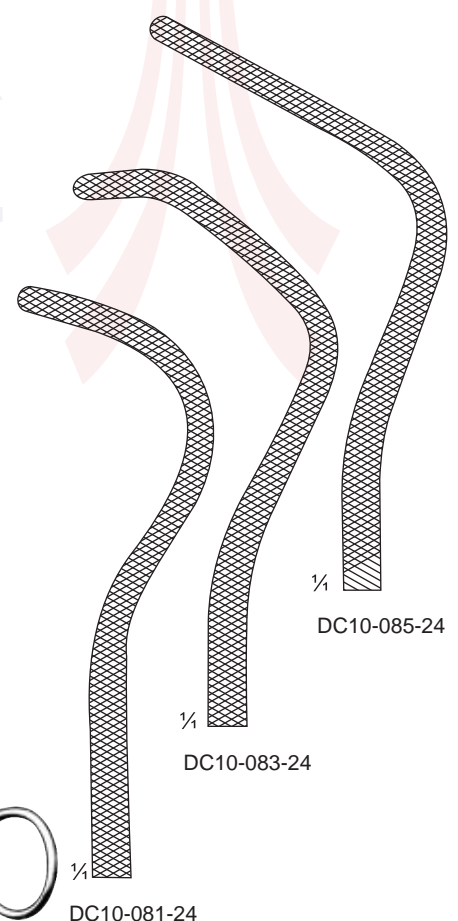

$\frac{1}{4}$   
DC10-081-24

$\frac{1}{4}$   
DC10-083-24

$\frac{1}{4}$   
DC10-085-24

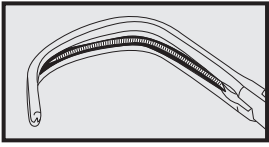

Pulmonic Stenosis and Aorta Clamps

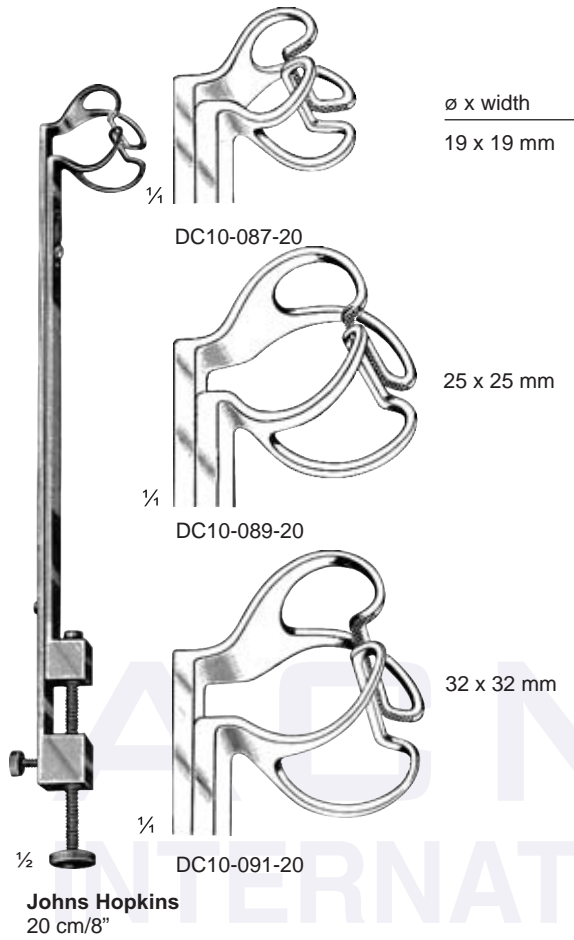

$\frac{1}{4}$  DC10-087-20  $\frac{\text{ø} \times \text{width}}{19 \times 19 \text{ mm}}$   
 $\frac{1}{4}$  DC10-089-20  $25 \times 25 \text{ mm}$   
 $\frac{1}{4}$  DC10-091-20  $32 \times 32 \text{ mm}$   
**Johns Hopkins**  
 20 cm/8"

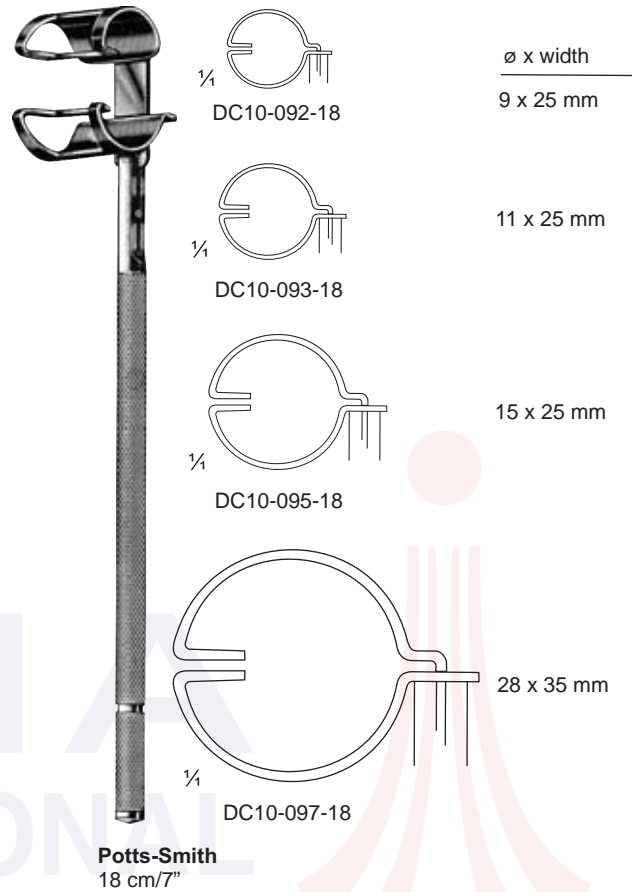

$\frac{1}{4}$  DC10-092-18  $\frac{\text{ø} \times \text{width}}{9 \times 25 \text{ mm}}$   
 $\frac{1}{4}$  DC10-093-18  $11 \times 25 \text{ mm}$   
 $\frac{1}{4}$  DC10-095-18  $15 \times 25 \text{ mm}$   
 $\frac{1}{4}$  DC10-097-18  $28 \times 35 \text{ mm}$   
**Potts-Smith**  
 18 cm/7"

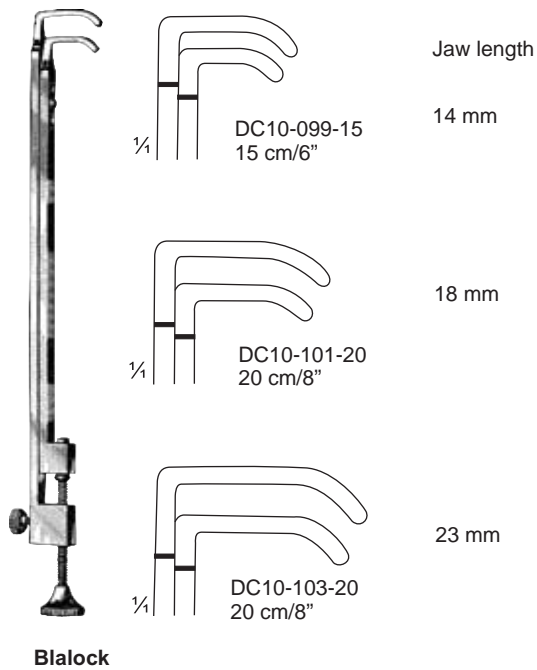

$\frac{1}{4}$  DC10-099-15  $\frac{\text{Jaw length}}{14 \text{ mm}}$   
 $15 \text{ cm}/6"$   
 $\frac{1}{4}$  DC10-101-20  $18 \text{ mm}$   
 $20 \text{ cm}/8"$   
 $\frac{1}{4}$  DC10-103-20  $23 \text{ mm}$   
 $20 \text{ cm}/8"$   
**Blalock**

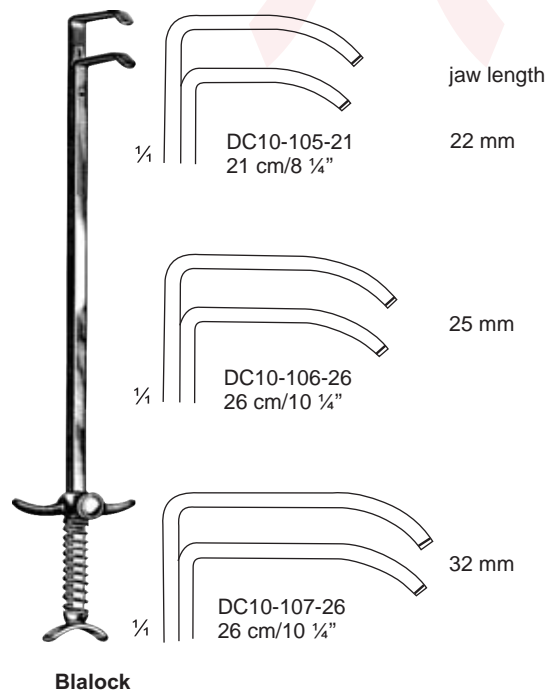

$\frac{1}{4}$  DC10-105-21  $\frac{\text{Jaw length}}{22 \text{ mm}}$   
 $21 \text{ cm}/8 \frac{1}{4}"$   
 $\frac{1}{4}$  DC10-106-26  $25 \text{ mm}$   
 $26 \text{ cm}/10 \frac{1}{4}"$   
 $\frac{1}{4}$  DC10-107-26  $32 \text{ mm}$   
 $26 \text{ cm}/10 \frac{1}{4}"$   
**Blalock**

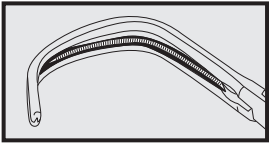

Blood Vessel Forceps with DeBakey Tothing



**DeBakey**  
DC10-109-26  
26 cm / 10"

1/2

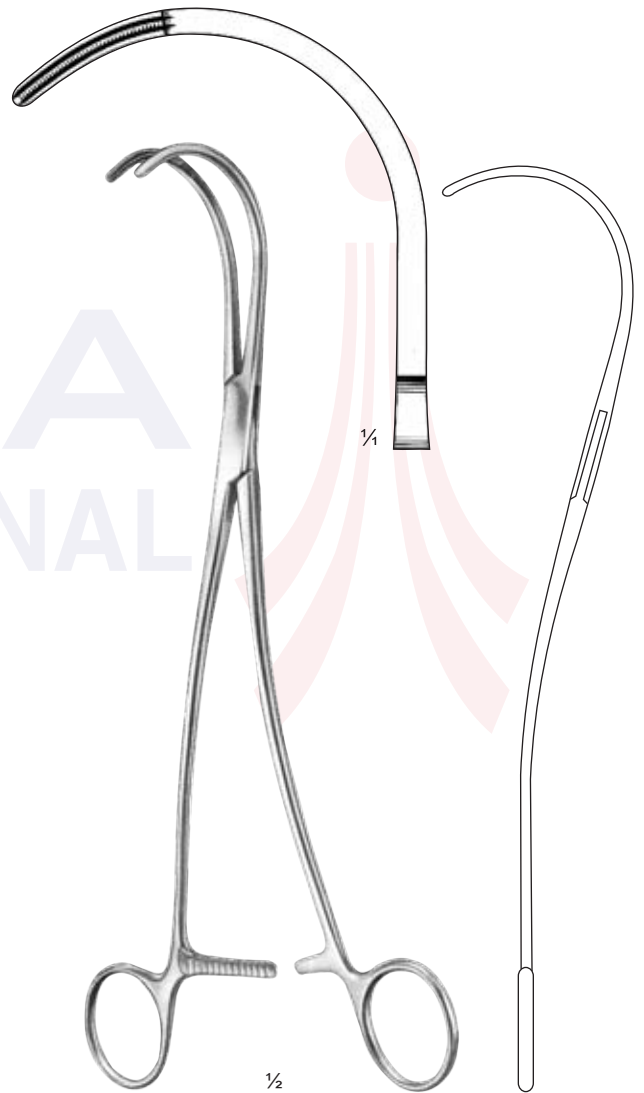

**DeBakey**  
DC10-109-25  
25 cm / 10"

1/2

Blood Vessel Forceps with DeBakey Tothing

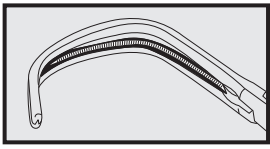

Top view

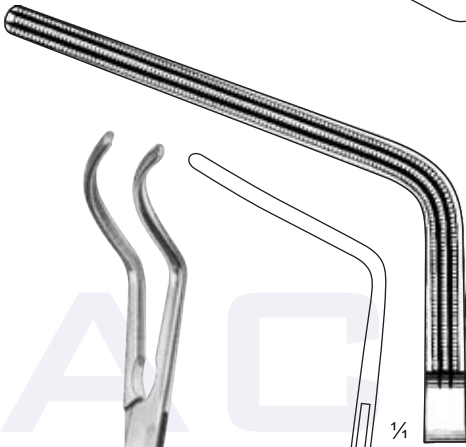
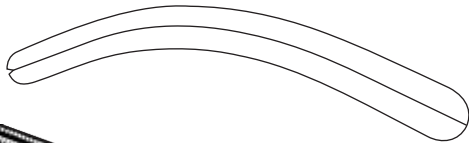

**DeBakey**  
DC10-111-27  
27 cm / 10 1/2"

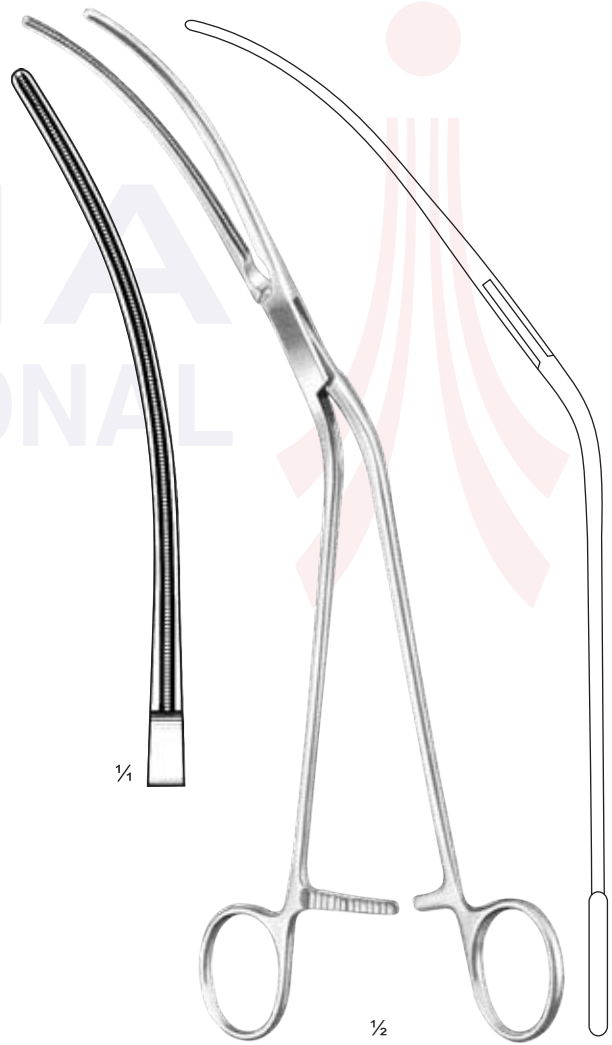

**DeBakey**  
DC10-113-28  
28 cm / 11"

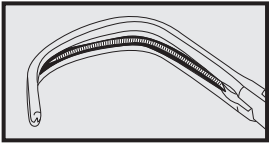

Blood Vessel Forceps with DeBakey Tothing

Anastomosis Forceps



**DeBakey-Glover**



DC10-115-21  
21cm/8¼"

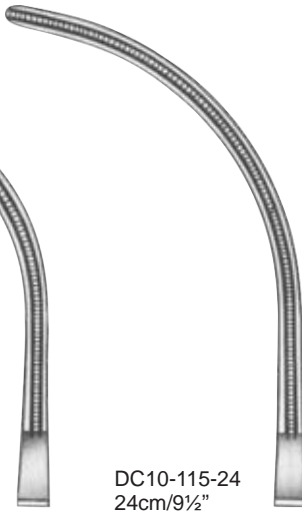

DC10-115-24  
24cm/9½"



DC10-117-21  
21cm/8¼"



DC10-117-26  
26cm/10¼"

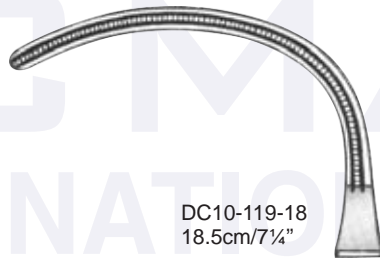

DC10-119-18  
18.5cm/7¼"

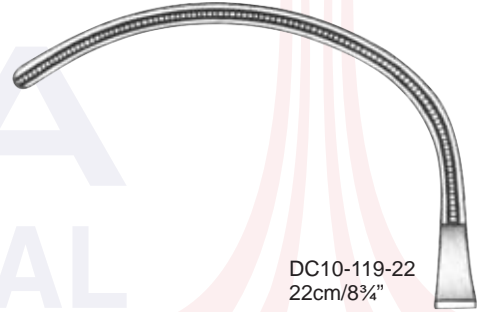

DC10-119-22  
22cm/8¾"



**DeBakey**  
DC10-121-12  
12 cm / 4 ¾"

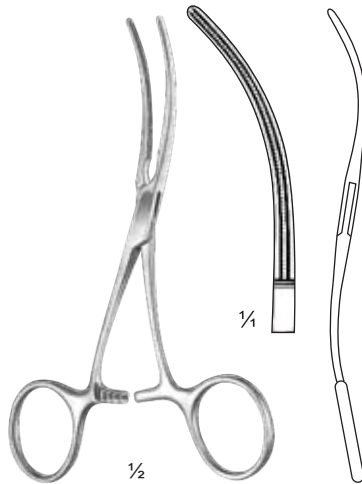

**DeBakey**  
DC10-123-12  
12 cm / 4 ¾"

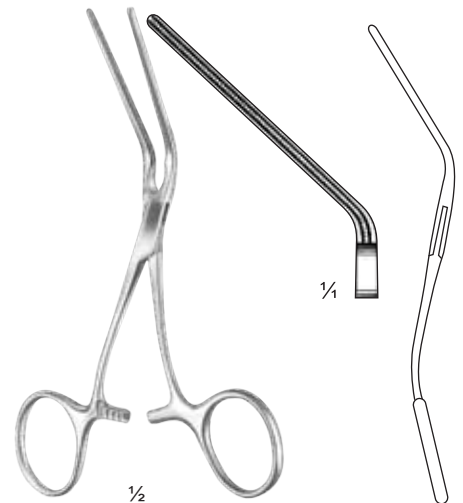

**DeBakey**  
DC10-125-13  
13 cm / 5 ¼"

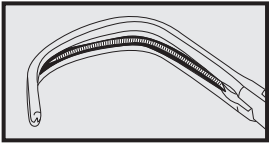

Blood Vessel Forceps with DeBakey Tothing

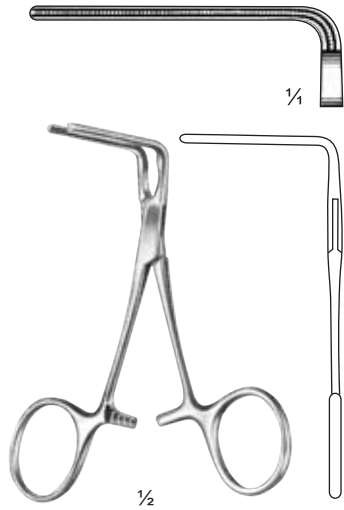

**DeBakey**  
DC10-127-10  
10 cm / 4"

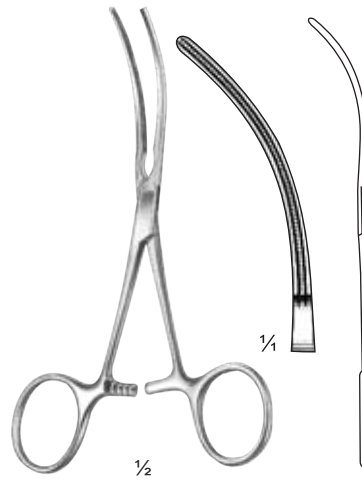

**DeBakey**  
DC10-127-11  
11 cm / 4 1/4"



**DeBakey**  
DC10-129-23  
23 cm / 9"

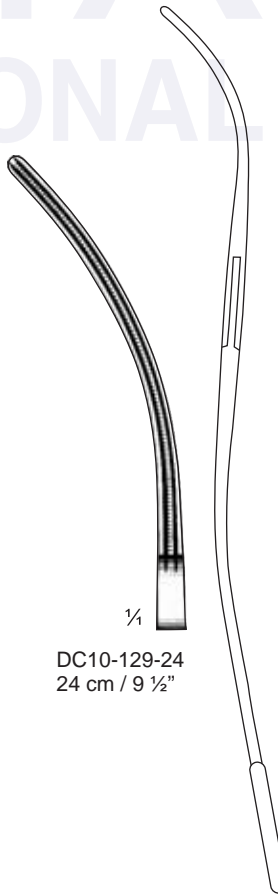

**DeBakey**  
DC10-129-24  
24 cm / 9 1/2"

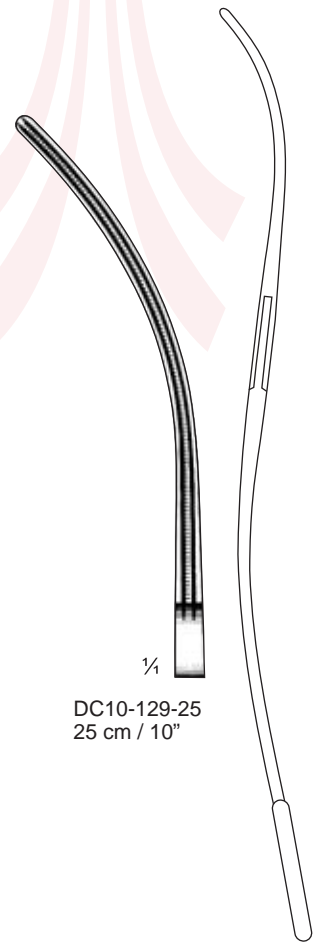

**DeBakey**  
DC10-129-25  
25 cm / 10"

**DeBakey**  
DC10-129-23 - DC10-129-25

Blood Vessel Forceps with DeBakey Toothing

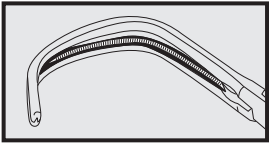

**Lambert-Kay**  
DC10-131-21  
21 cm / 8 1/4"

1/4

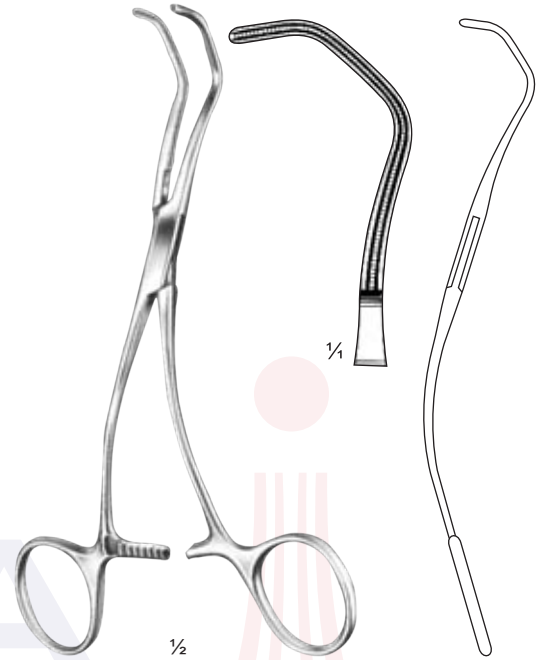
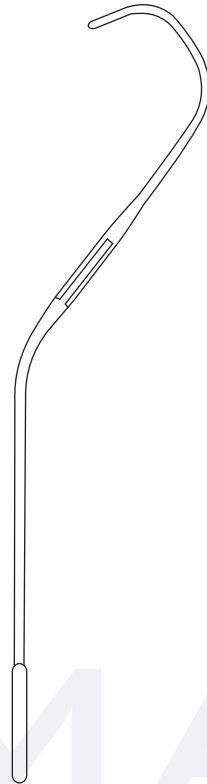

**DeBakey**  
DC10-133-17  
17 cm / 6 3/4"

1/4

1/2

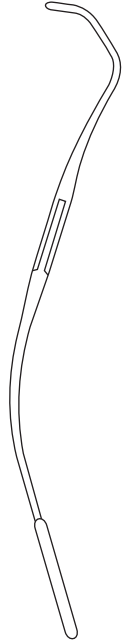

**DeBakey**  
DC10-135-18 - DC10-135-27

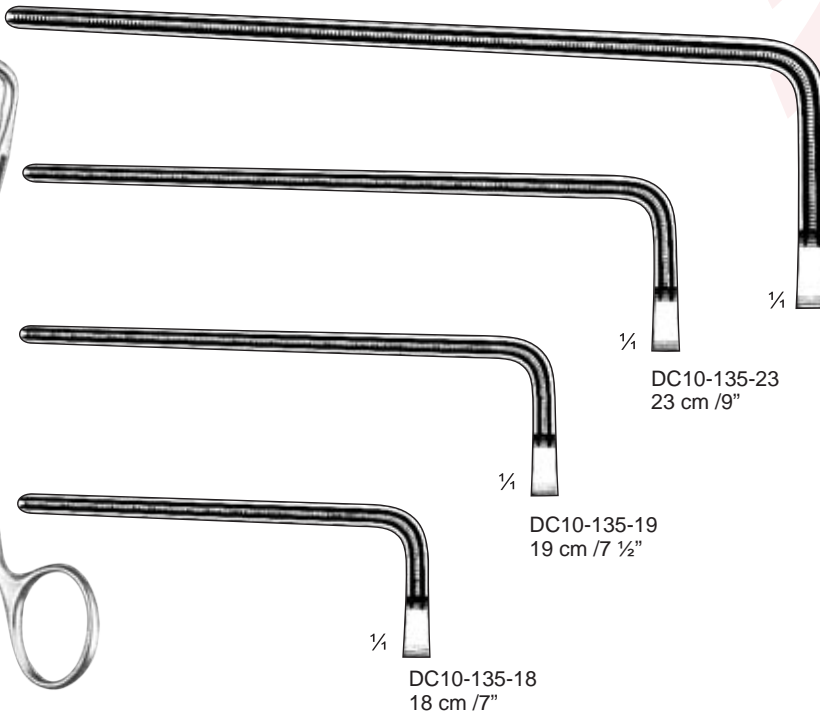

1/4

DC10-135-18  
18 cm / 7"

1/4

DC10-135-23  
23 cm / 9"

1/4

DC10-135-27  
27 cm / 10 1/2"

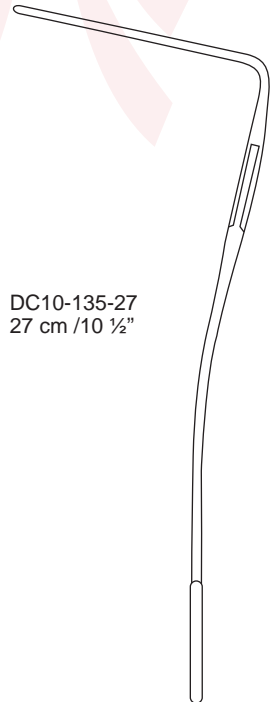

Blood Vessel Forceps with DeBakey Tothing

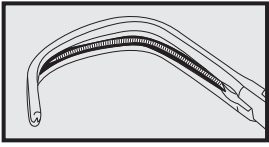

1/4  
DC10-137-20 20 cm / 8"  
1/4  
DC10-137-21 21 cm / 8 1/4"  
1/4  
DC10-137-25 25 cm / 10"  
1/4  
DC10-137-29 29 cm / 11 3/4"

DC10-137-20 - DC10-137-29

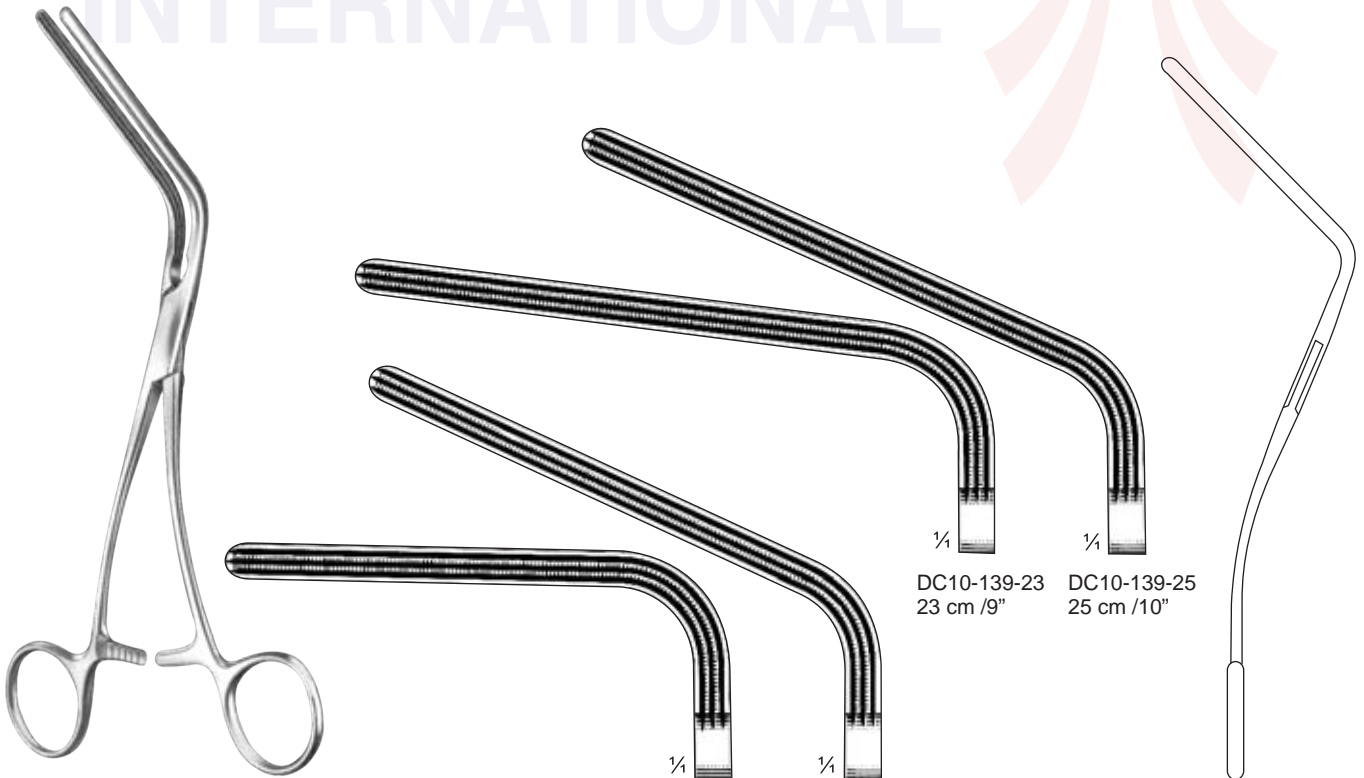

1/4  
DC10-139-23 23 cm / 9"  
1/4  
DC10-139-25 25 cm / 10"  
1/4  
DC10-139-18 18 cm / 7"  
1/4  
DC10-139-20 20 cm / 8"

DeBakey



Blood Vessel Forceps with DeBakey Tothing

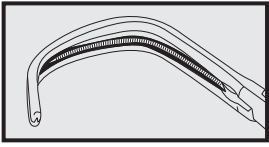

**DeBakey**  
DC10-141-24  
24 cm / 9 1/2"

DC10-143-24  
24 cm / 9 1/2"

DC10-145-30  
30 cm / 11 3/4"

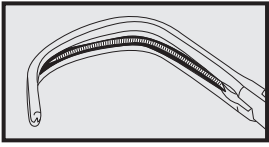

Blood Vessel Forceps with DeBakey Tothing



**Beck**  
DC10-147-17  
17 cm / 6 3/4"

**Potts**  
DC10-149-22  
22 cm / 8 3/4"

**DeBakey**  
DC10-151-19 - DC10-152-23

ACMA INTERNATIONAL



**DeBakey**  
DC10-153-20  
20 cm / 8"

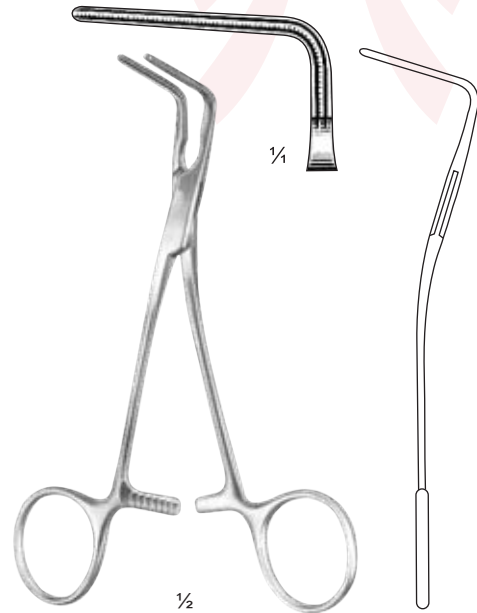

**DeBakey**  
DC10-155-15  
15 cm / 6"

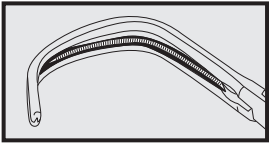

Blood Vessel Forceps with DeBakey Tothing

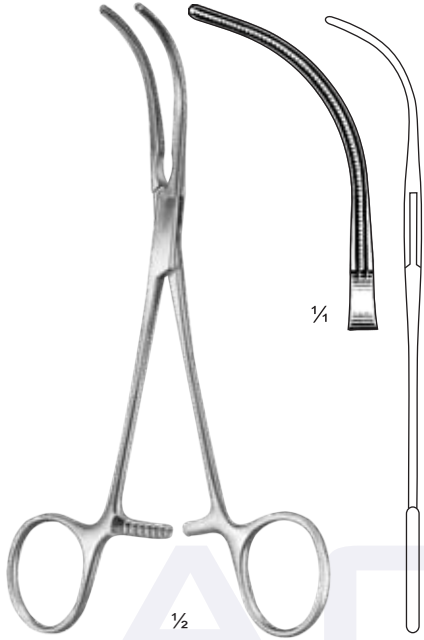

**DeBakey**  
DC10-157-16  
16 cm / 6 1/4"

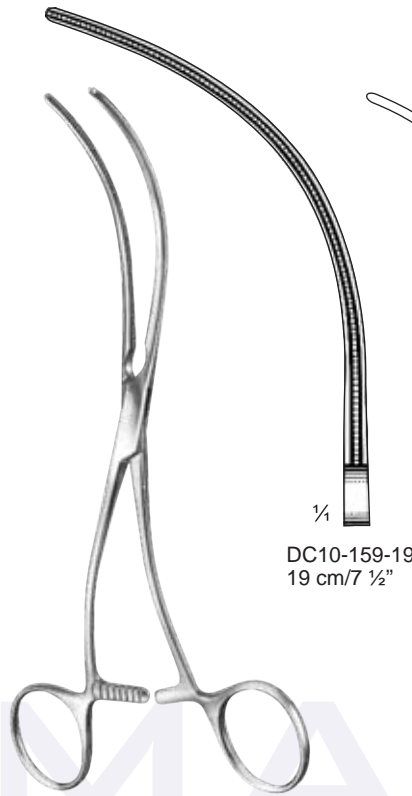

**DeBakey**  
DC10-159-19 - DC10-159-20

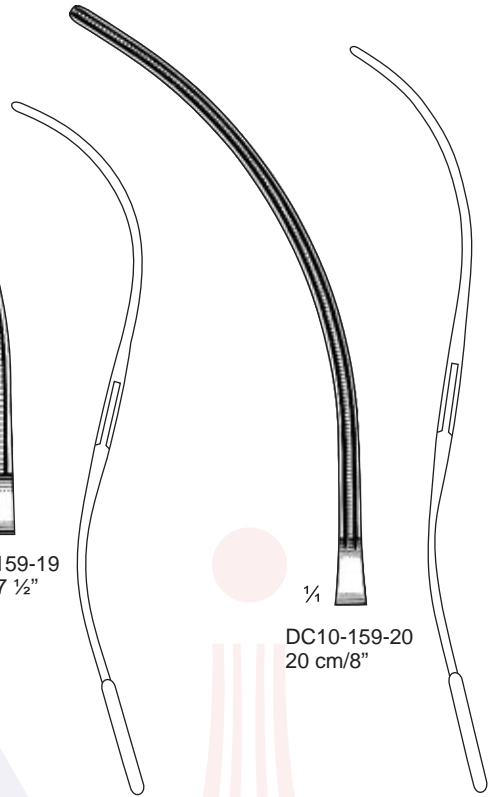

**DC10-159-20**  
20 cm / 8"

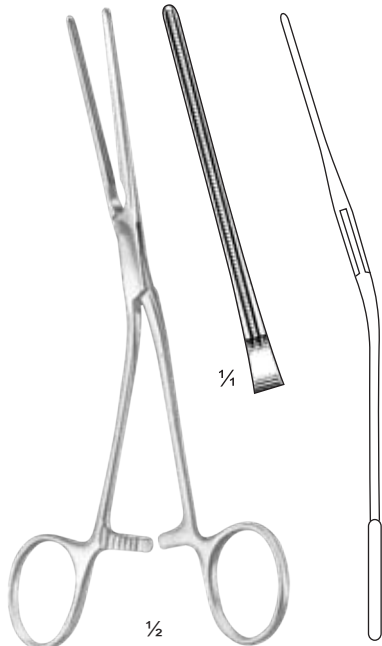

**DeBakey**  
DC10-161-17  
17 cm / 6 3/4"

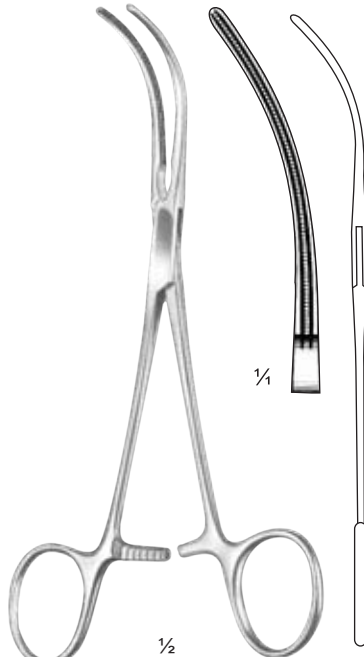

**Glover**  
DC10-163-17  
17 cm / 6 3/4"

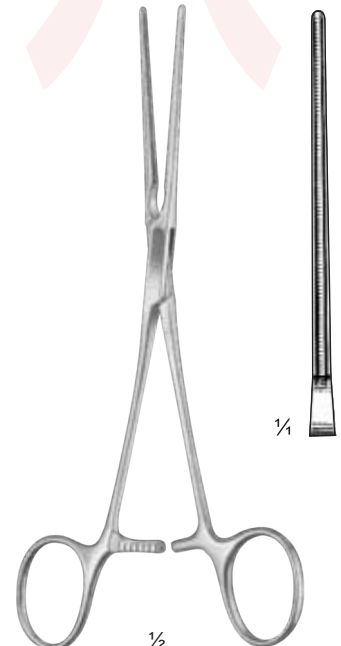

**DeBakey**  
DC10-165-17  
17 cm / 6 3/4"

Atrauma Blood Vessel Forceps with DeBakey Toothing

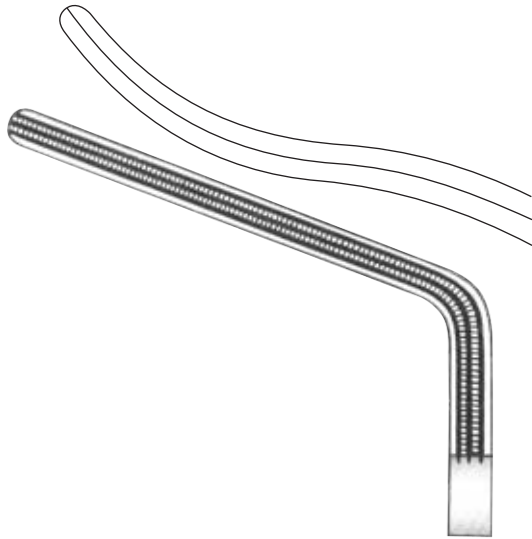
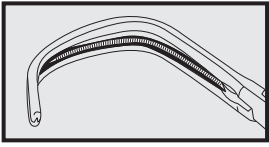

Aortic Forceps, angled, cup shaped jaw

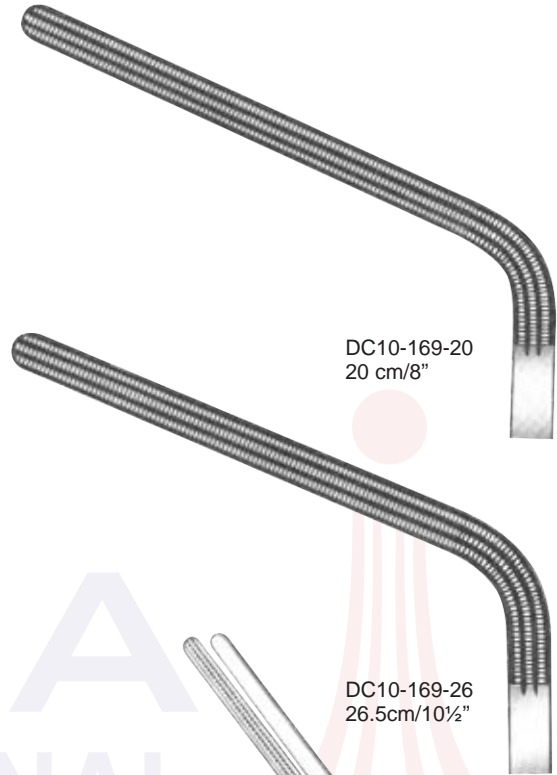

DC10-169-20  
20 cm/8"

DC10-169-26  
26.5cm/10½"



**DeBakey**  
DC10-167-27  
27cm/10¼"

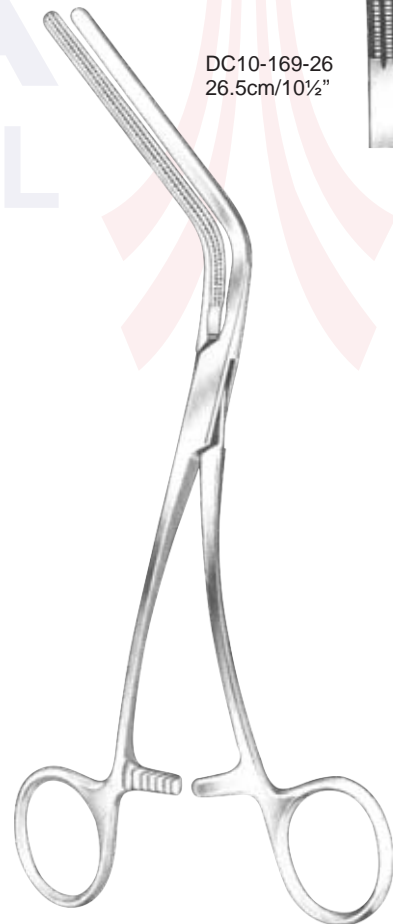

**DeBakey-Morris**

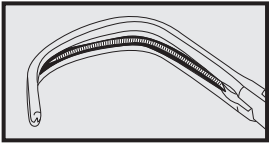

Blood Vessel Forceps with DeBakey Tothing

Tangential Occlusion Forceps

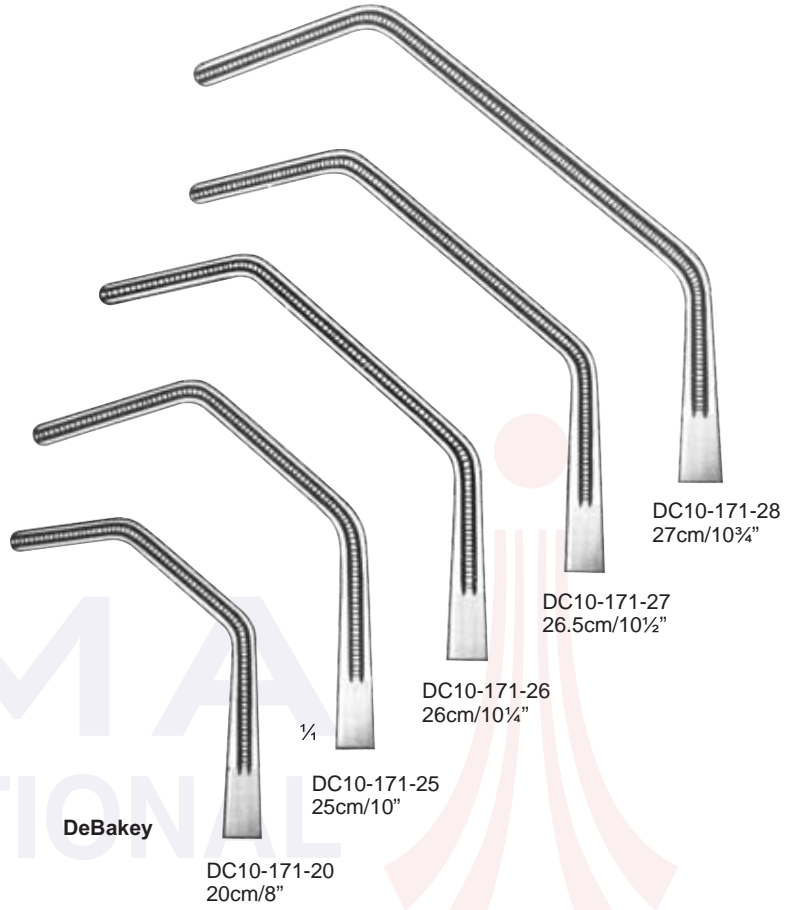
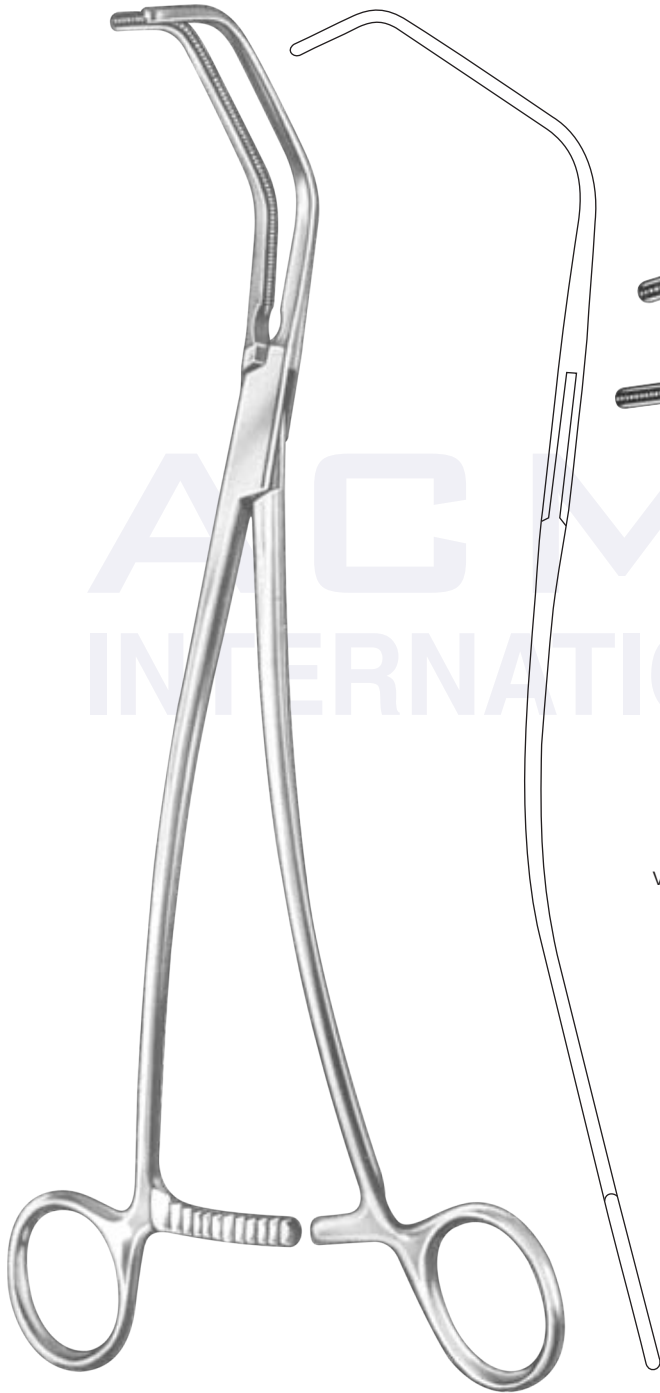

DeBakey

Vena cave Clamps



DeBakey-Satinsky

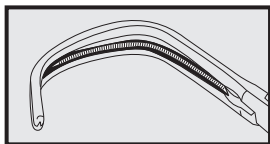

Blood Vessel Forceps with DeBakey Tothing

Also Patent  
Ductus Forceps

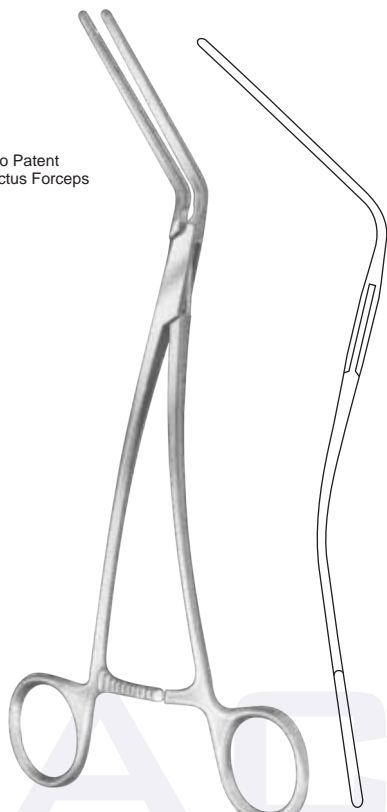

DeBakey

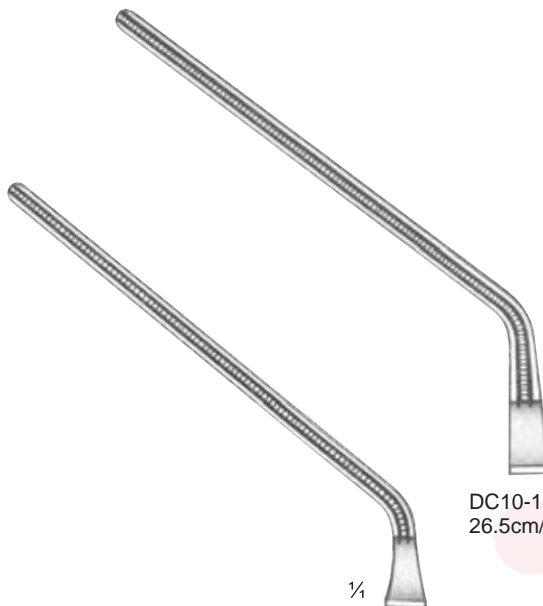

DC10-175-26  
26.5cm/10½"

¼

DC10-175-19  
19cm/7½"

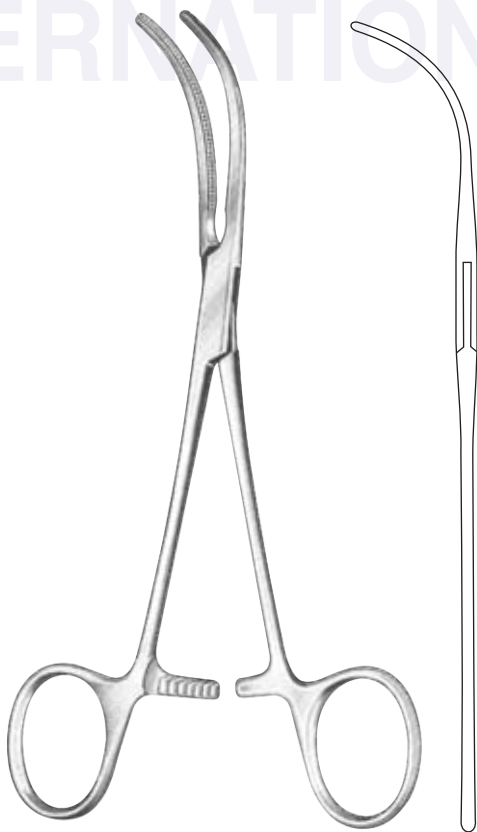

DeBakey  
DC10-177-16  
16cm/6¼"



¼

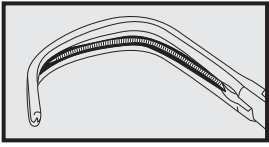

Blood Vessel Forceps with DeBakey Tothing

Anastomosis Forceps



ACMA INTERNATIONAL

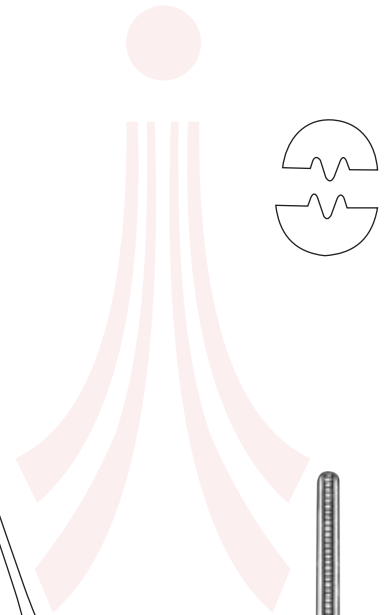

DeBakey-Reynolds

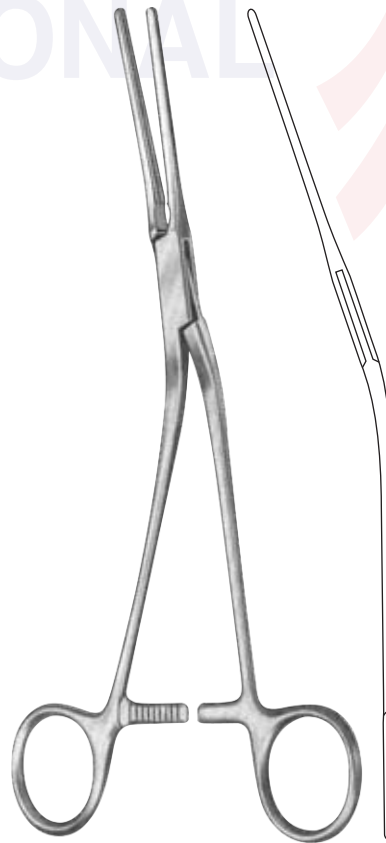

DeBakey

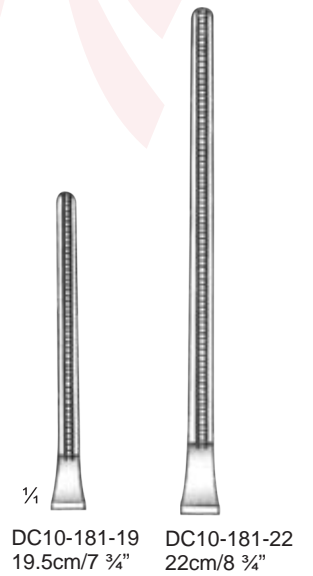

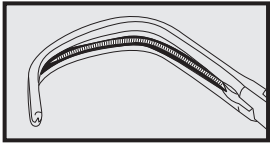

Blood Vessel Forceps with DeBakey Tothing

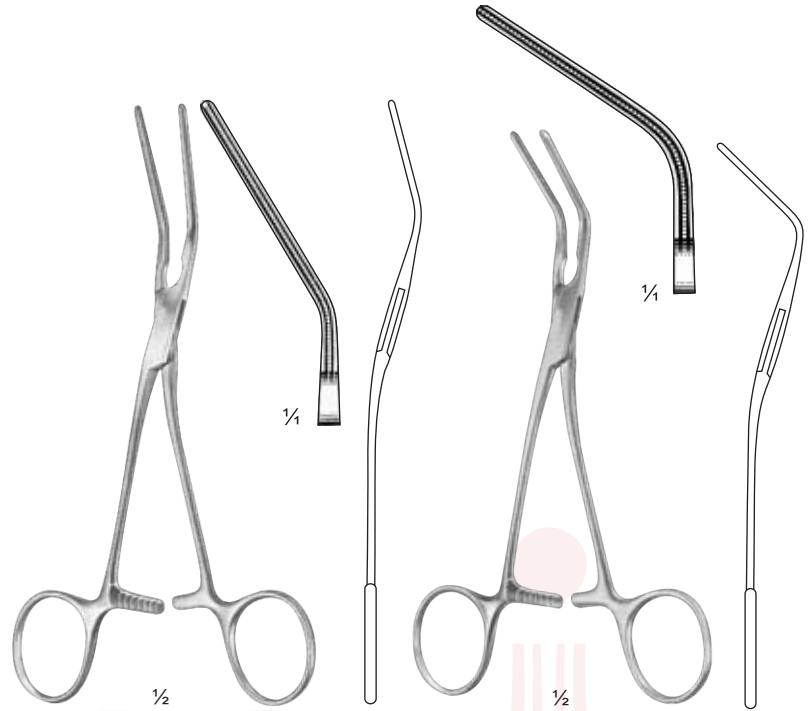
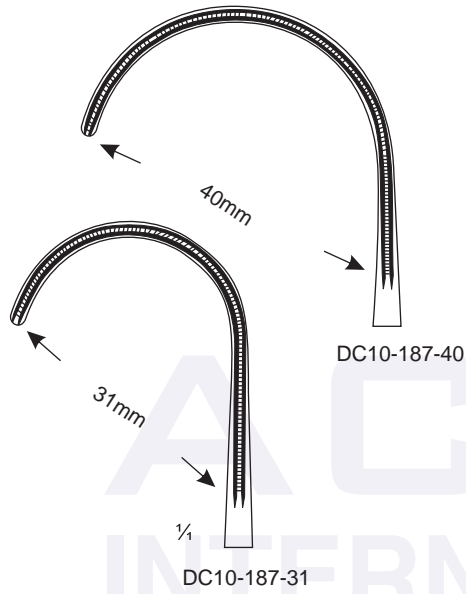

DeBakey  
DC10-183-16  
16 cm / 6 1/4"

DeBakey  
DC10-185-15  
15 cm / 6"



DeBakey  
17cm/6 3/4"

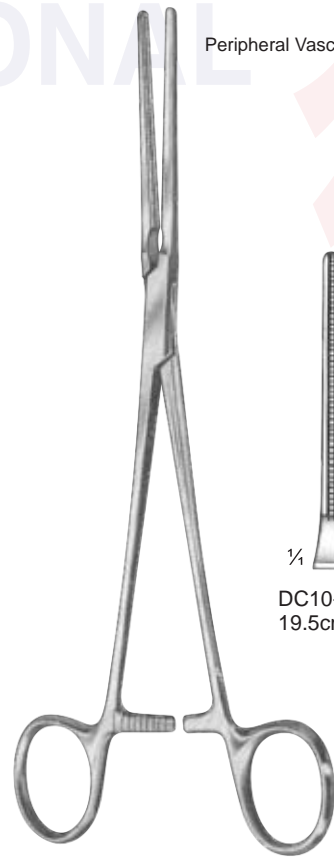

DeBakey

Peripheral Vascular Forceps

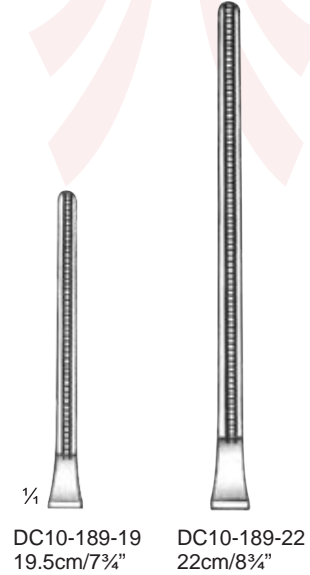

DC10-189-19  
19.5cm/7 3/4"

DC10-189-22  
22cm/8 3/4"



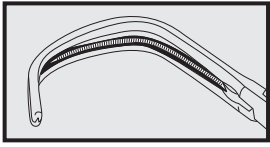

Blood Vessel Forceps with DeBakey Toothing



DeBakey-Bahnson

Blood Vessel Forceps with DeBakey Tothing

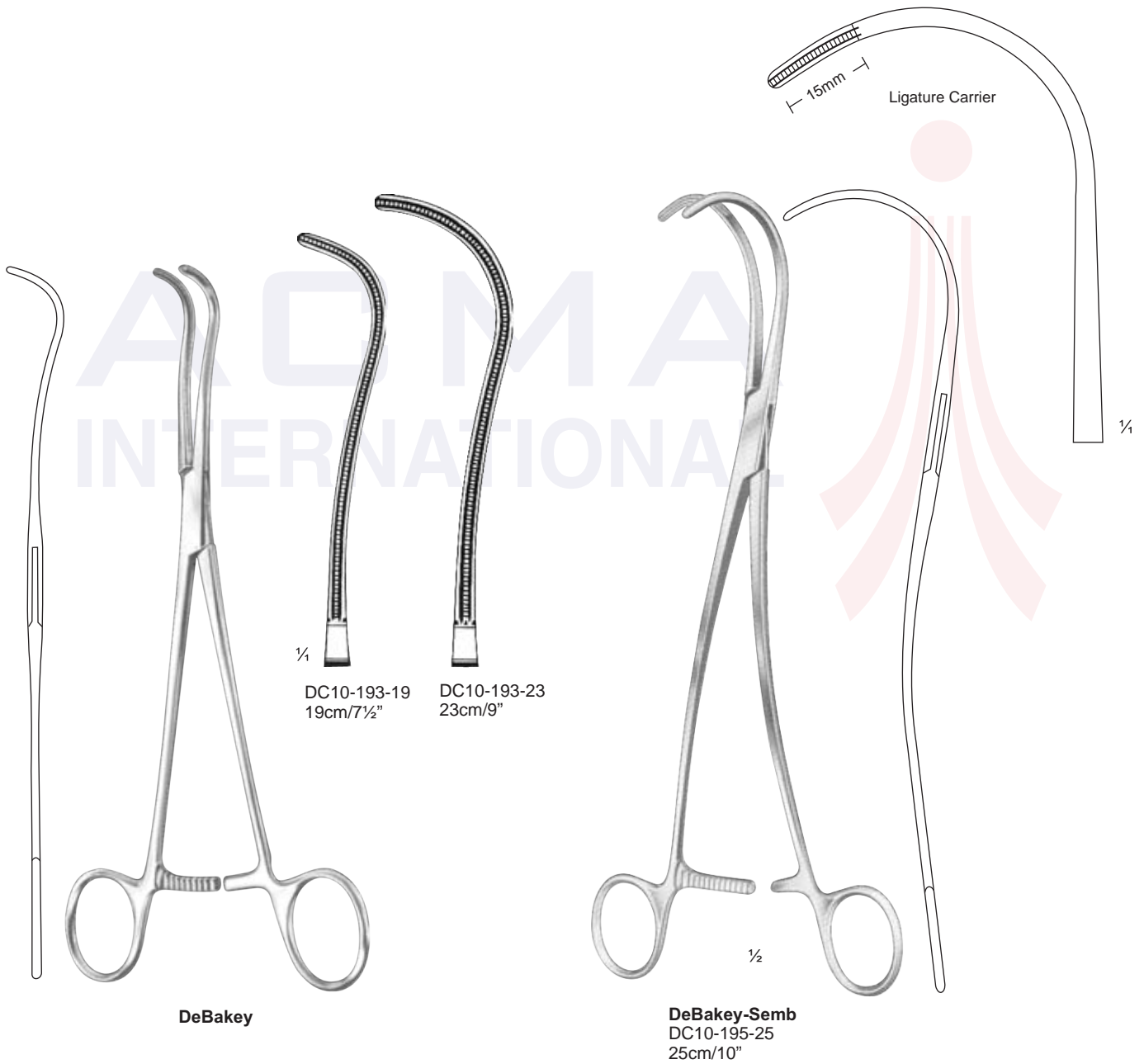
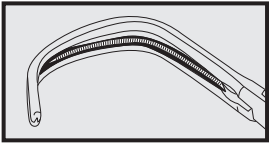

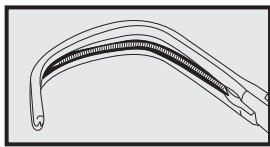

Blood Vessel Forceps with DeBakey Tothing

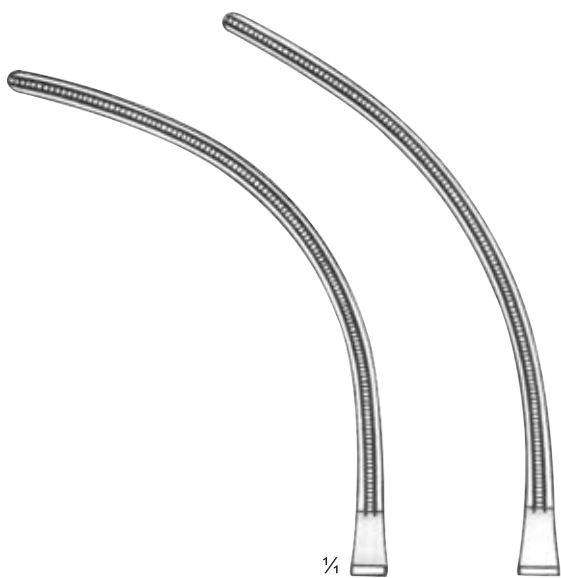

¼

DC10-197-19  
19cm/7½"

DC10-197-20  
20cm/8"

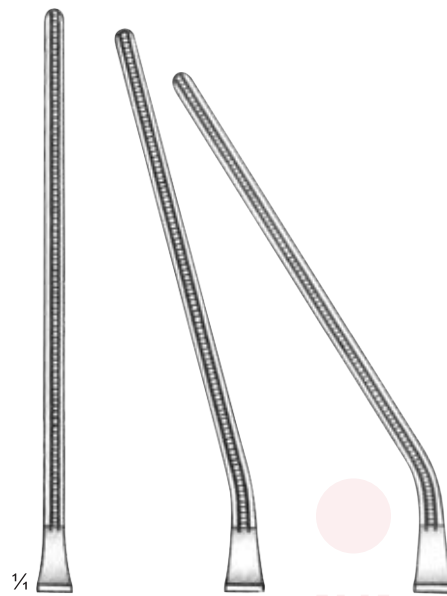

¼

DC10-199-19  
19.5cm/7¾"

DC10-201-20  
19.5cm/7¾"

DC10-203-19  
19.5cm/7¾"

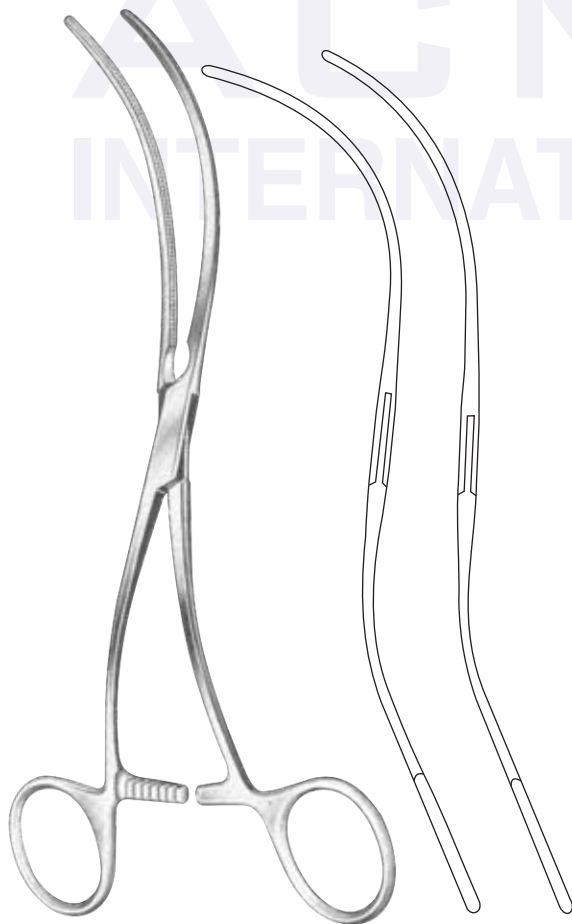

DeBakey

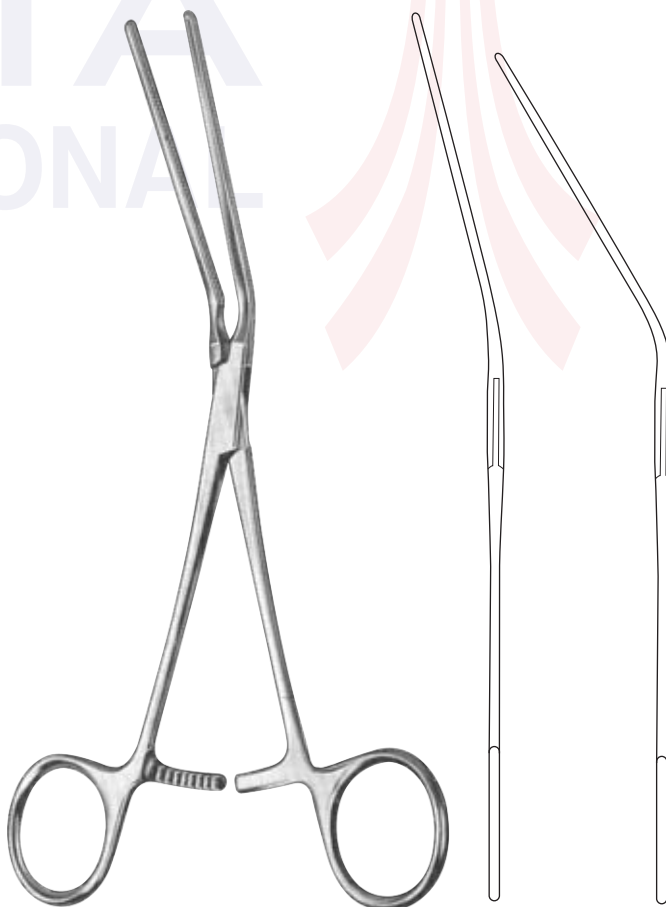

Leland-Jones

Blood Vessel Forceps & Clamps

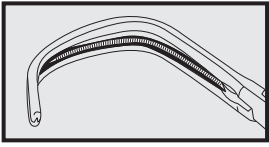

1/4

DC10-205-17  
17cm/6 3/4"

DC10-207-17  
17.5cm/7"

DC10-209-18  
18cm/7"

1/4

Cooley

Cooley  
DC10-211-17  
17cm/6 3/4"



Cooley-Beck

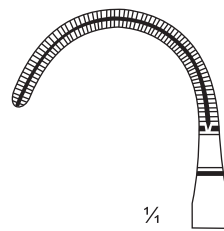
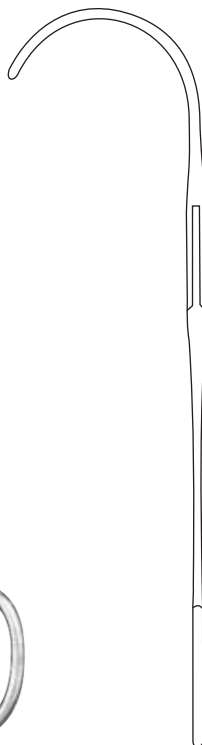

1/4

DC10-213-15  
15cm/6"

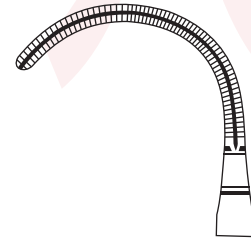

DC10-213-16  
15.5cm/6"

Vascular Clamps

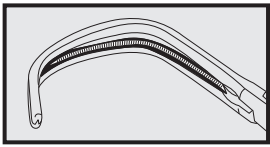

Atrauma Blood Vessel Forceps & Clamps

Multi Purpose Forceps



Cooley

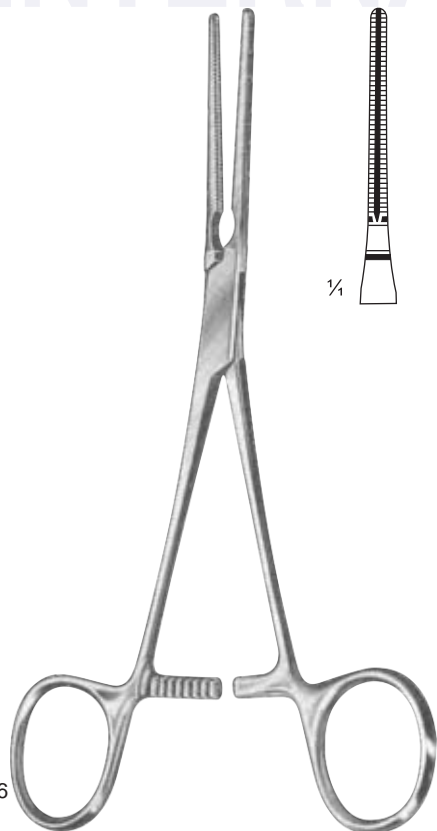
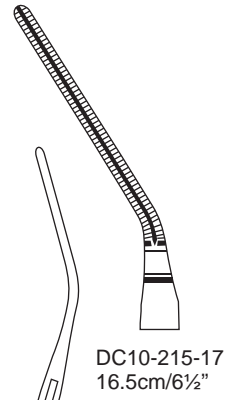
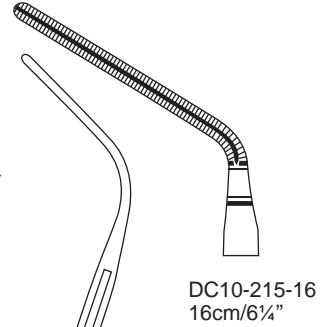
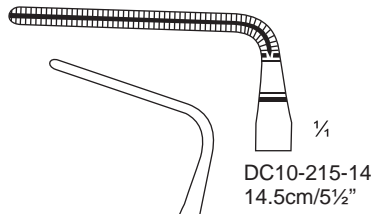

Cooley  
DC10-217-16  
16cm/6¼"

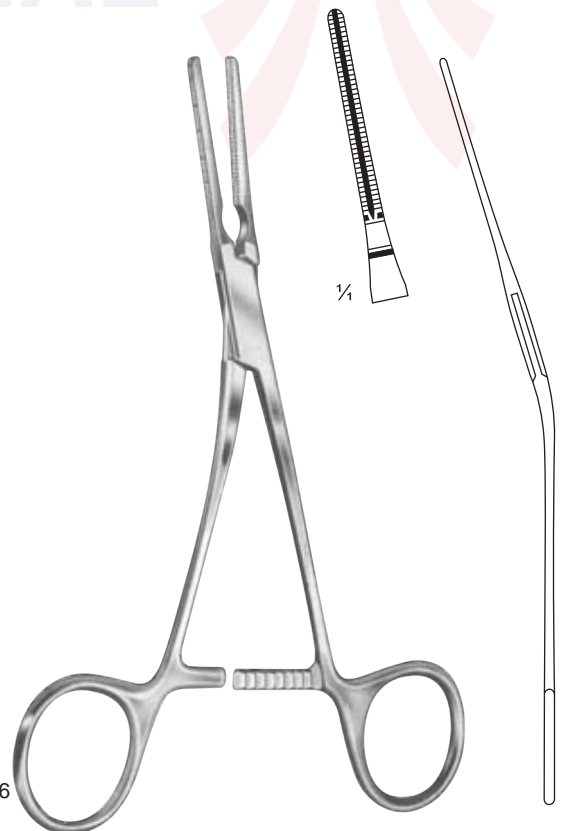

Cooley  
DC10-219-16  
16cm/6¼"

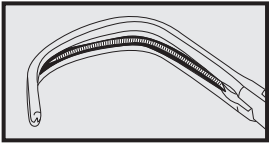

Blood Vessel Forceps & Clamps

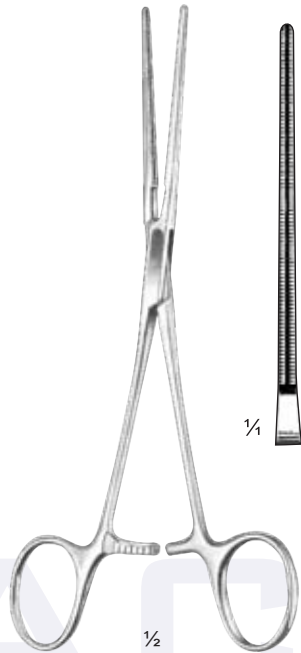

**Cooley**  
DC10-221-17  
17 cm / 6 3/4"

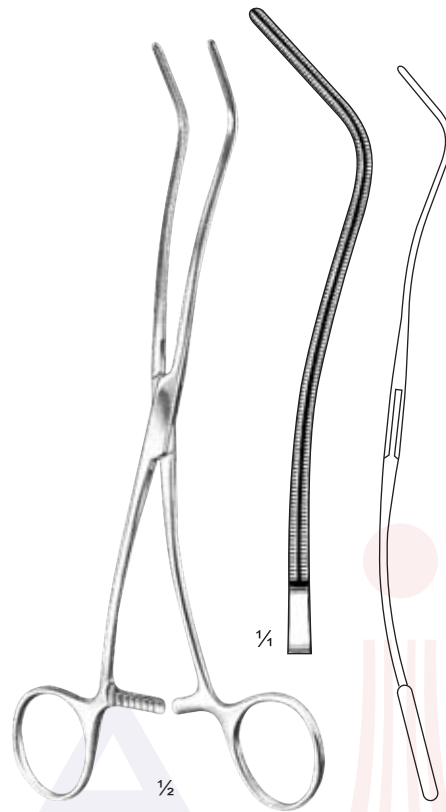

**Cooley**  
DC10-223-20  
20 cm / 8"

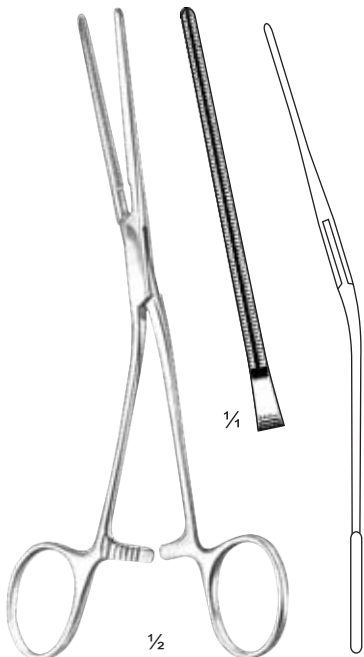

**Cooley**  
DC10-225-17  
17 cm / 6 3/4"

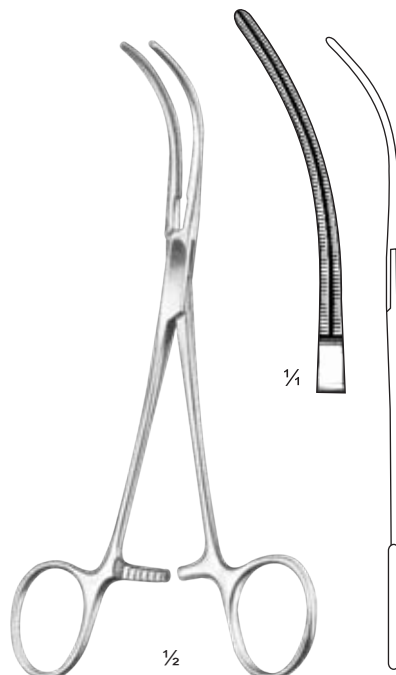

**Cooley**  
DC10-227-17  
17 cm / 6 3/4"

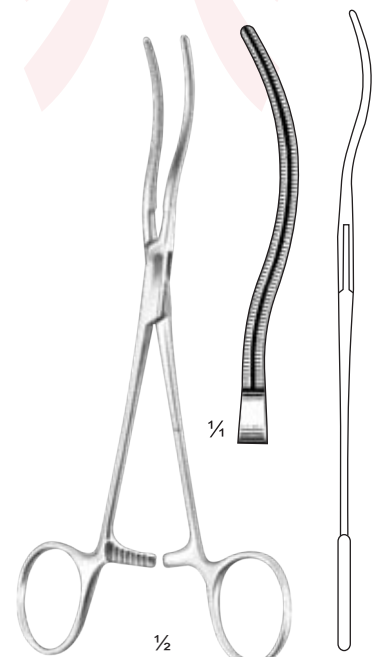

**Cooley**  
DC10-229-17  
17 cm / 6 3/4"

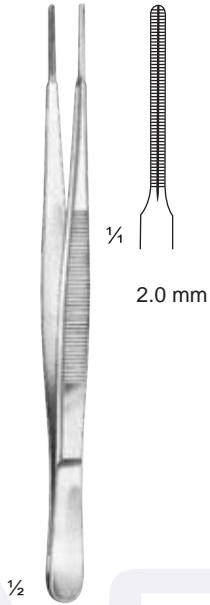
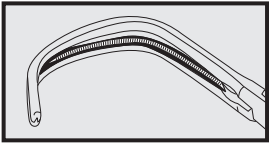

**Cooley**  
DC10-231-16 = 16 cm / 6 1/4"  
DC10-231-20 = 20 cm / 8"

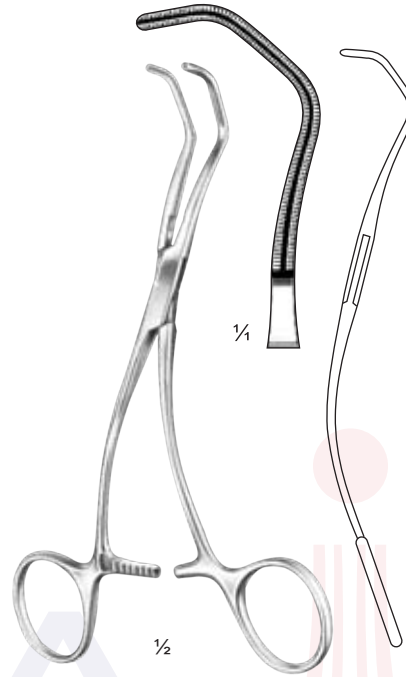

**Cooley**  
DC10-233-16  
16 cm / 6 1/4"

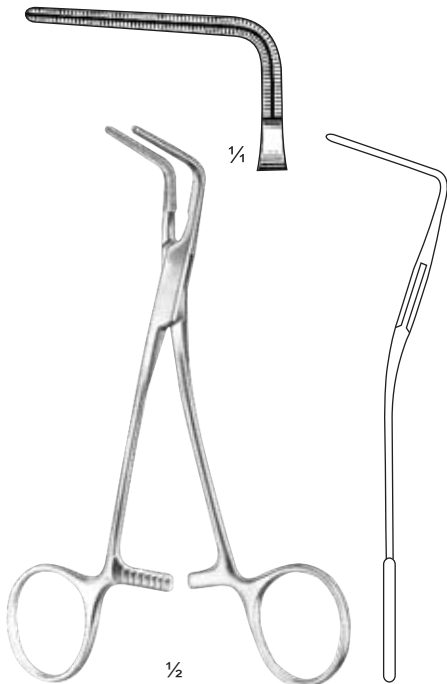

**Cooley**  
DC10-235-15  
15 cm / 6"

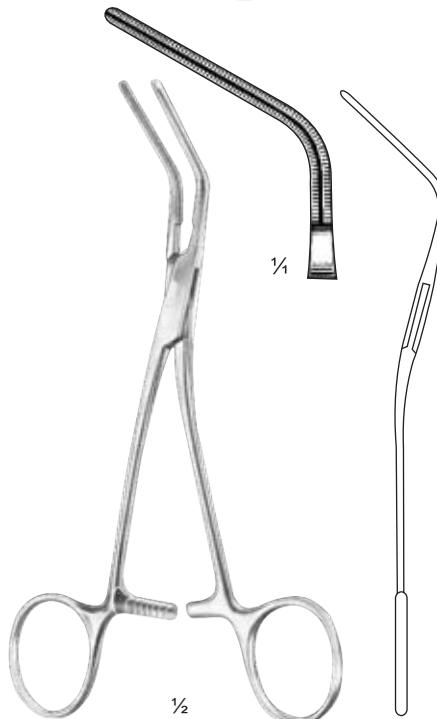

**Cooley**  
DC10-235-16  
15.5 cm / 6"

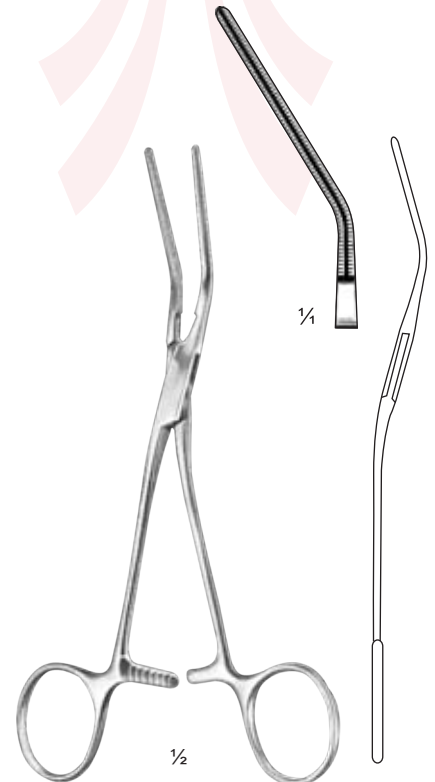

**Cooley**  
DC10-235-17  
17 cm / 6 3/4"

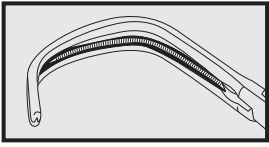

Blood Vessel Forceps & Clamps

Anastomosis Forceps

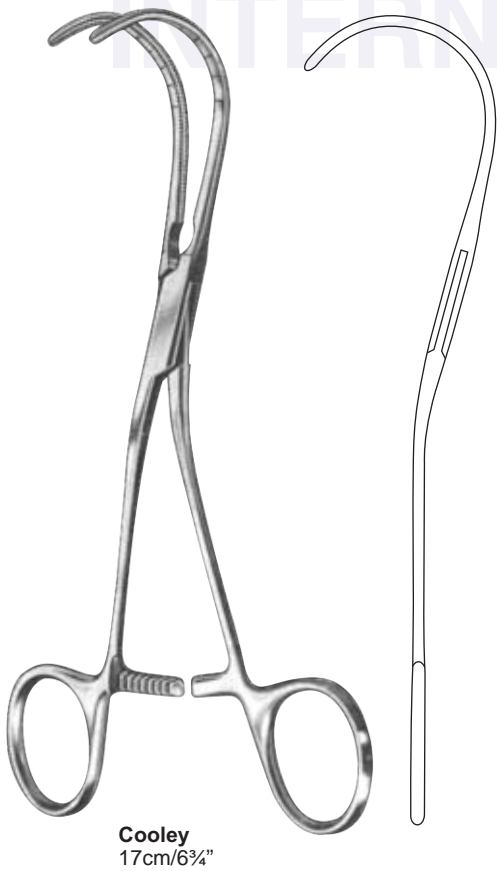
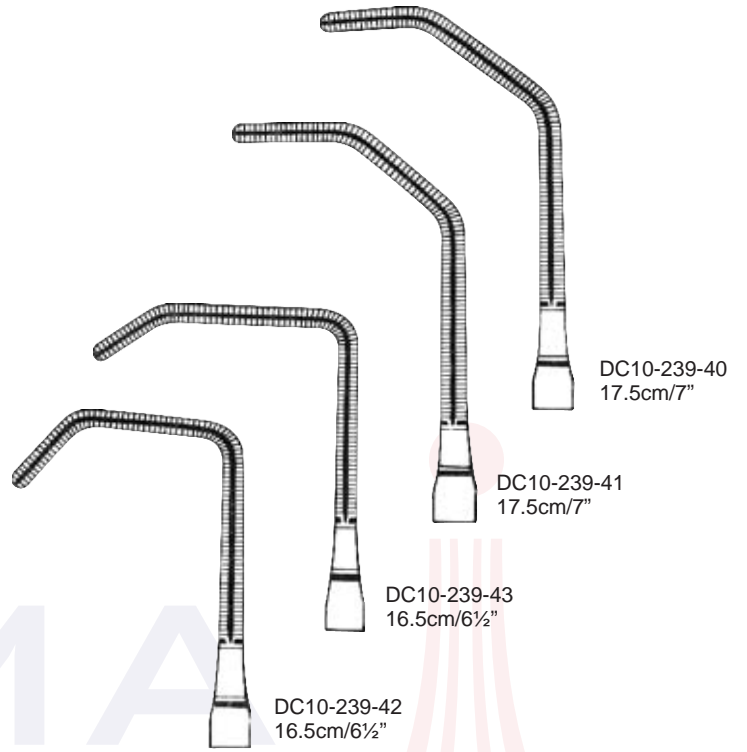
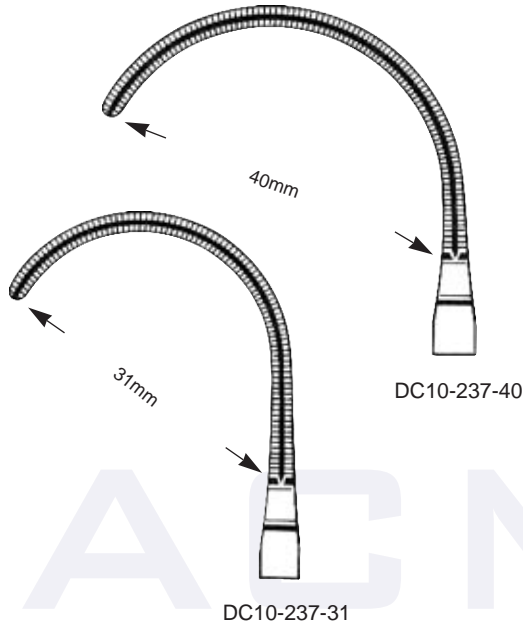

**Cooley**  
17cm/6 3/4"

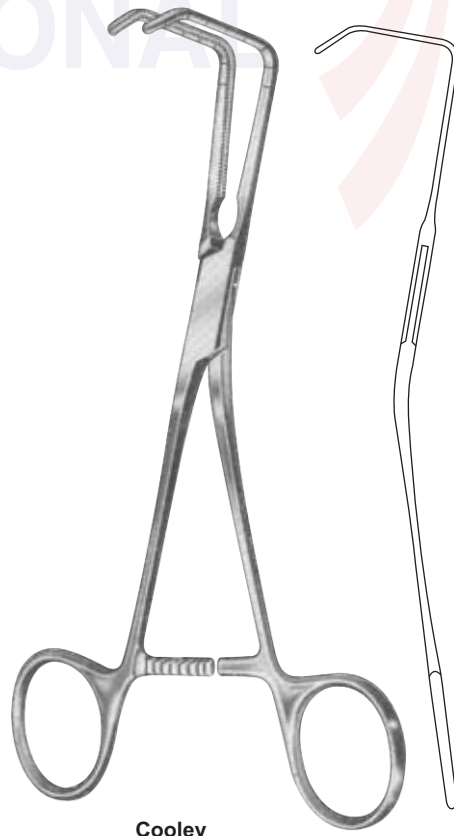

**Cooley**



Blood Vessel Forceps & Clamps

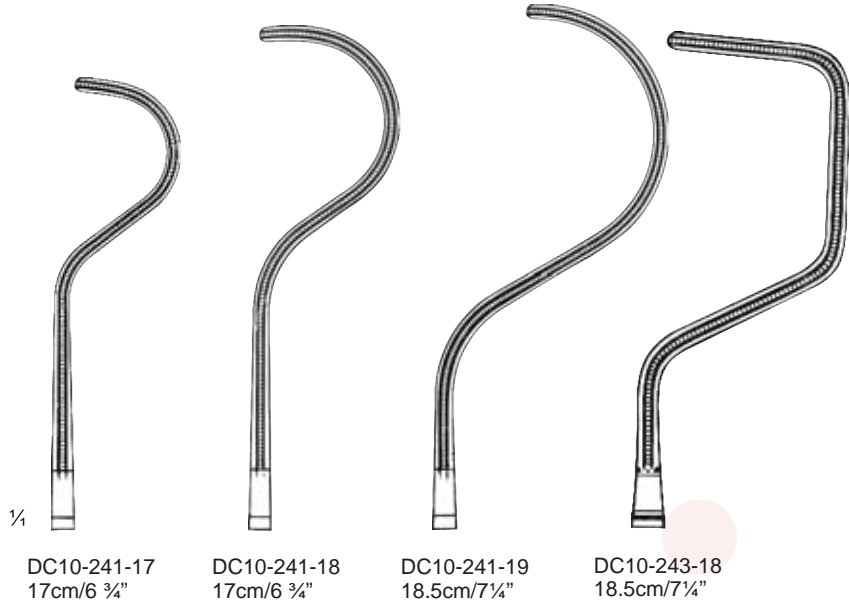
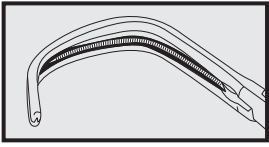

¼

DC10-241-17  
17cm/6 ¾"

DC10-241-18  
17cm/6 ¾"

DC10-241-19  
18.5cm/7 ¼"

DC10-243-18  
18.5cm/7 ¼"

ACMA  
INTERNATIONAL

Dale

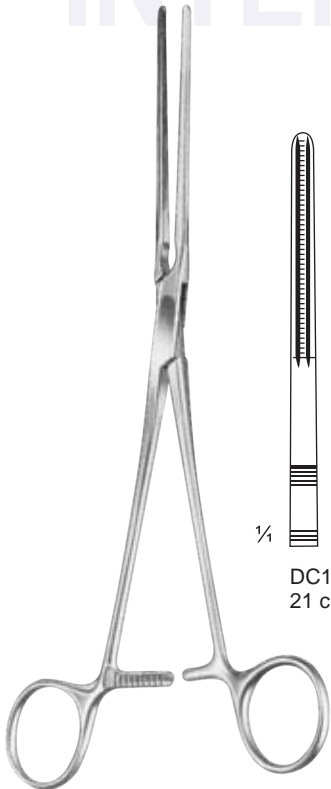

¼

DC10-245-21  
21 cm/8 ¼"

¼

DC10-245-22  
22 cm/8 ¾"

Potts

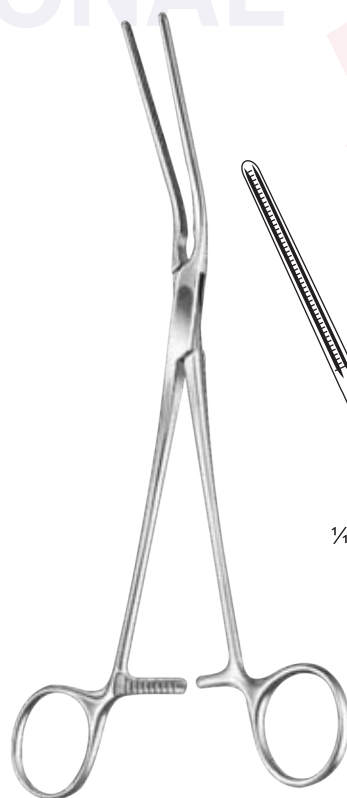

¼

DC10-247-21  
21 cm/8 ¼"

¼

DC10-247-22  
22 cm/8 ¾"

Potts

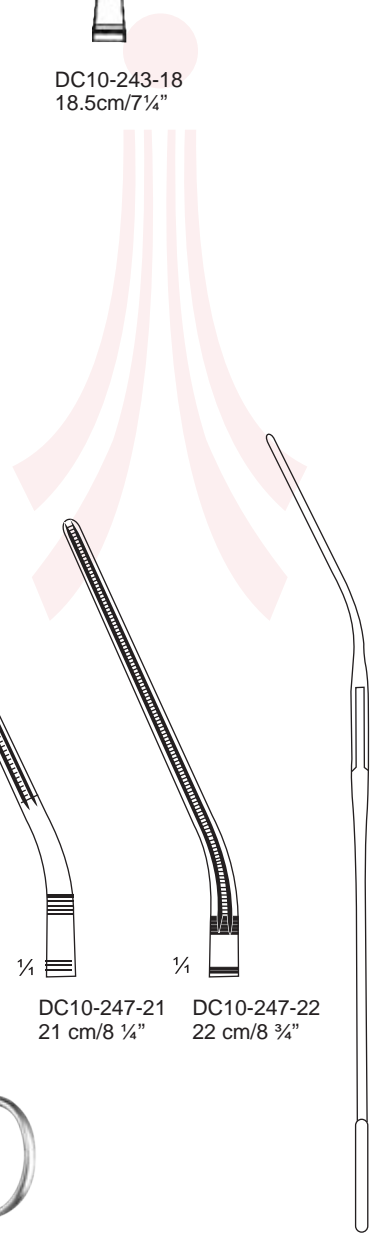

Blood Vessel Forceps & Clamps

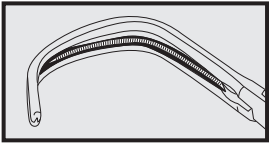

1/4

DC10-249-21  
21 cm/8 1/4"

1/4

DC10-249-22  
22 cm/8 3/4"

1/2

1/4

**Potts**  
DC10-249-21 - DC10-249-22

**Potts**  
DC10-251-22  
22cm /8 3/4"

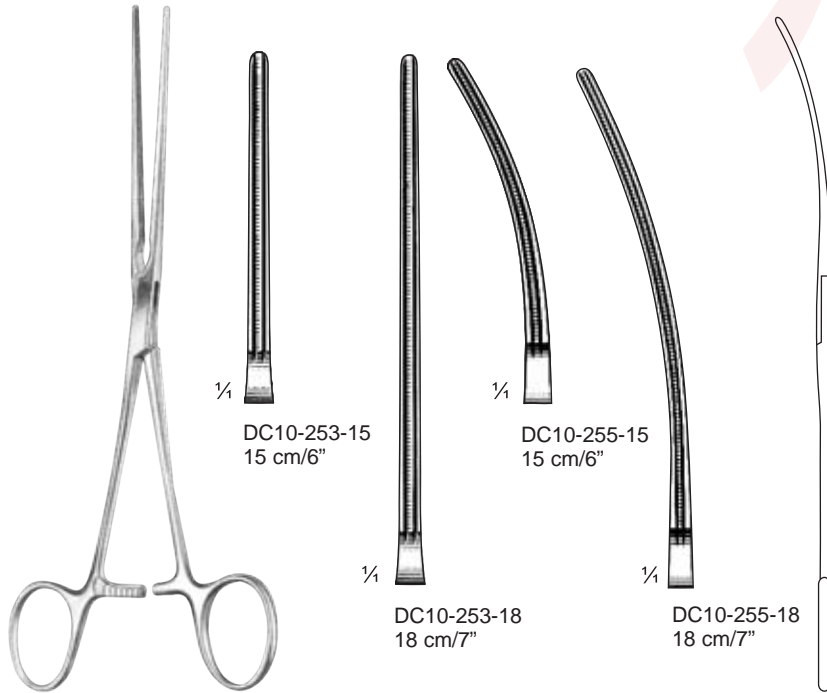

1/4

DC10-253-15  
15 cm/6"

1/4

DC10-255-15  
15 cm/6"

1/4

DC10-253-18  
18 cm/7"

1/4

DC10-255-18  
18 cm/7"

**Bainbridge**

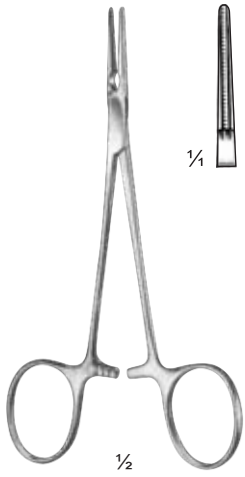
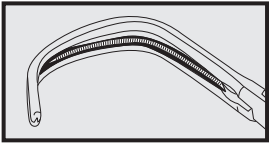

**Mosquito**  
DC10-257-12  
12 cm / 4 3/4"

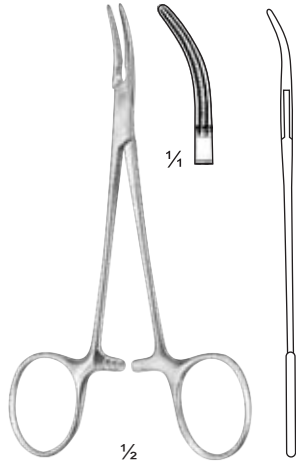

**Mosquito**  
DC10-259-12  
12 cm / 4 3/4"

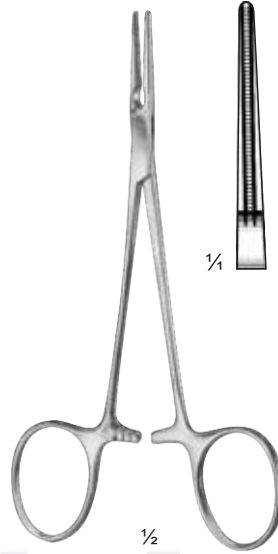

**Pean**  
DC10-261-14  
14 cm / 5 1/2"

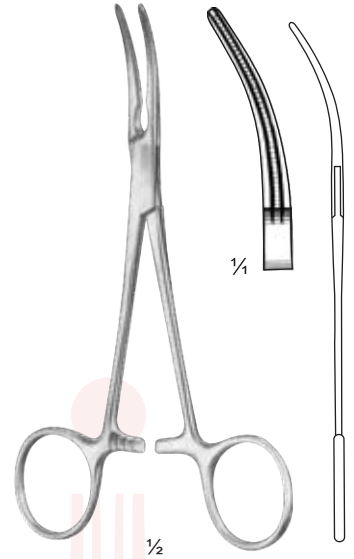

**Pean**  
DC10-263-14  
14 cm / 5 1/2"

ACMA  
INTERNATIONAL



**Leland-Jones**  
DC10-265-18 - DC10-265-20

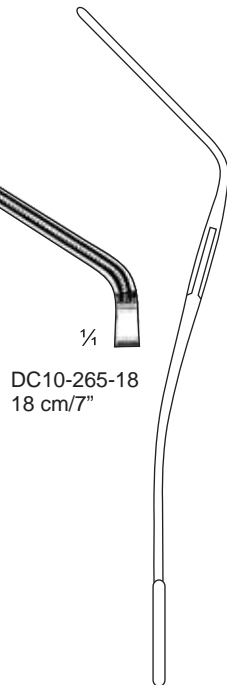

DC10-265-18  
18 cm / 7"



DC10-265-19  
19 cm / 7 1/2"

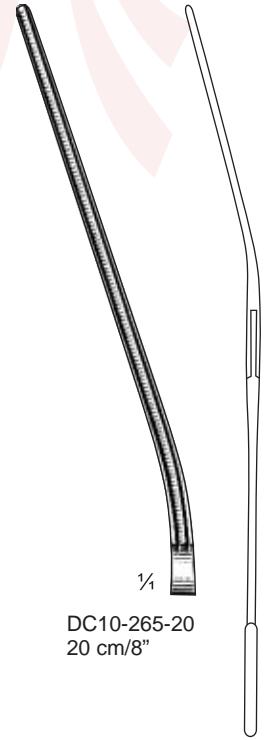

DC10-265-20  
20 cm / 8"

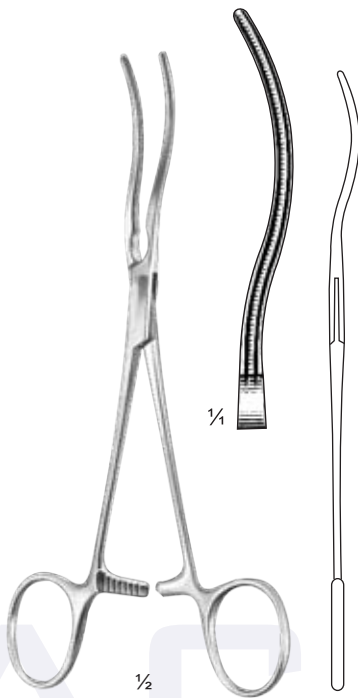
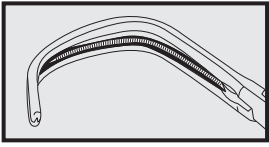

DC10-267-17  
17 cm / 6 3/4"

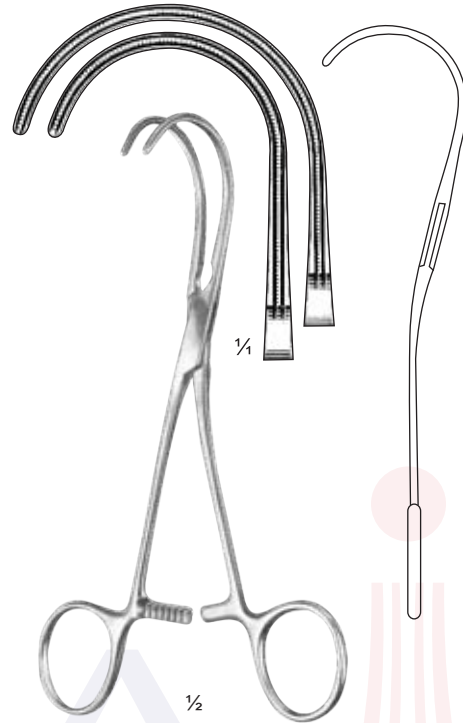

DC10-269-16 = 16 cm / 6 1/4"  
DC10-271-17 = 17 cm / 6 3/4"



Glover



DC10-275-20  
DC10-277-20  
20.5cm/8"



DC10-275-22  
DC10-277-22  
22cm/8 3/4"



DC10-275-26  
DC10-277-26  
26cm/10 1/4"

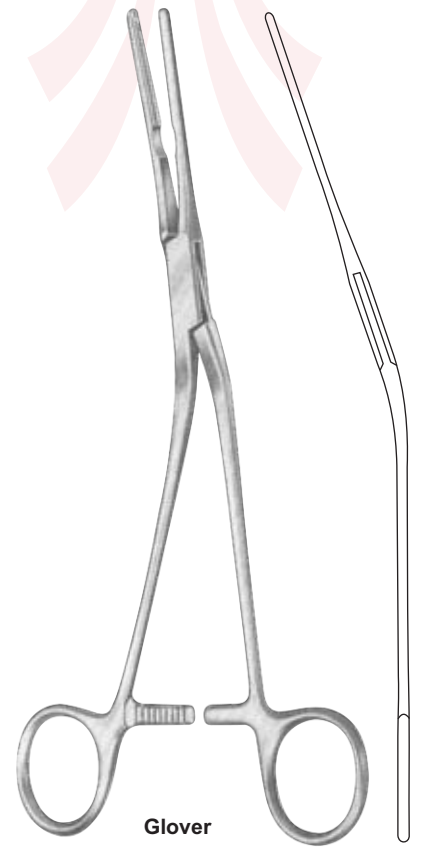

Glover

Blood Vessel Forceps & Clamps

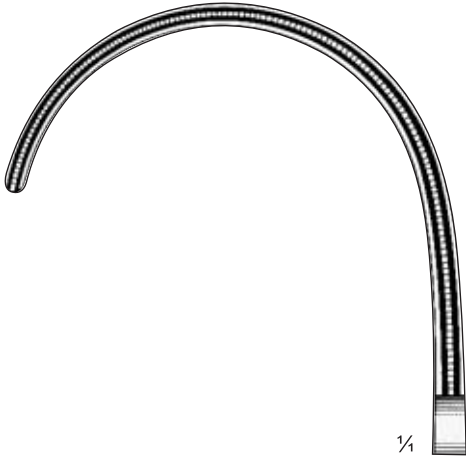
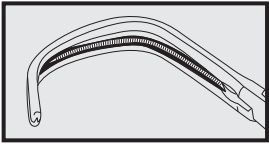

¼  
DC10-279-02

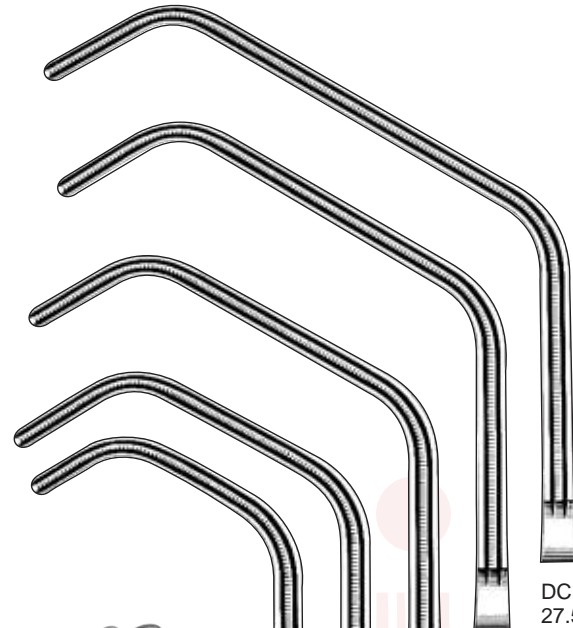

DC10-281-27  
27.5 cm / 11"

DC10-281-26  
26.5 cm / 10 ½"

DC10-281-25  
25 cm / 10"

¼  
DC10-281-24  
24 cm / 9 ¾"

DC10-281-20  
20.5 cm / 8"

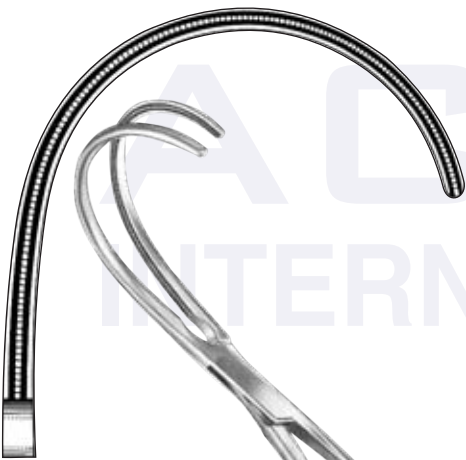

DC10-279-01



½

**Weber**  
26 cm / 10 ¼"



**Satinsky**  
DC10-281-20 - DC10-281-27

Blood Vessel Forceps & Clamps

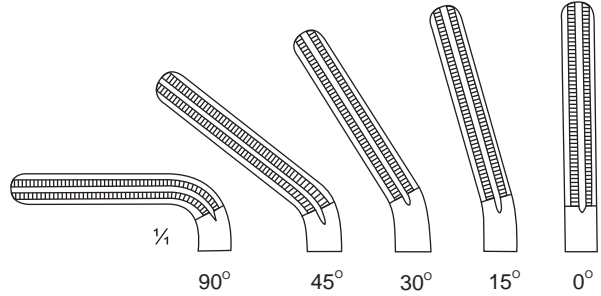
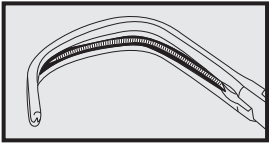

	cm	inch.	angle	weight
DC10-283-00	15	6	0°	28 g
DC10-283-15	15	6	15°	28 g
DC10-283-30	15	6	30°	28 g
DC10-283-45	15	6	45°	28 g
DC10-283-90	14	5 1/2	90°	28 g



Dardik

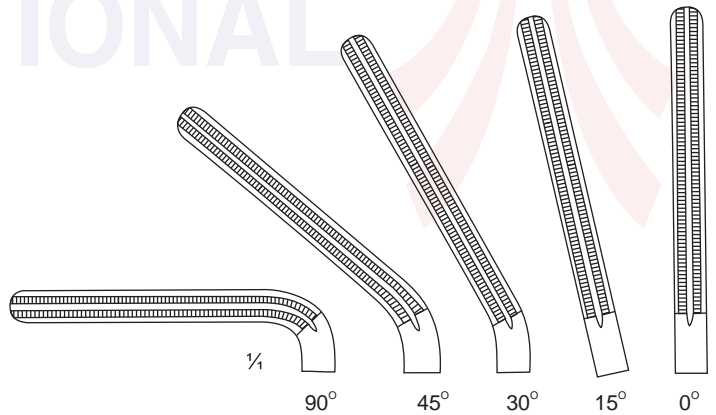

	cm	inch.	angle	weight
DC10-285-00	17	6 3/4	0°	28 g
DC10-285-15	17	6 3/4	15°	28 g
DC10-285-30	17	6 3/4	30°	28 g
DC10-285-45	17	6 3/4	45°	28 g
DC10-285-90	16	6 1/4	90°	28 g

Blood Vessel Forceps & Clamps

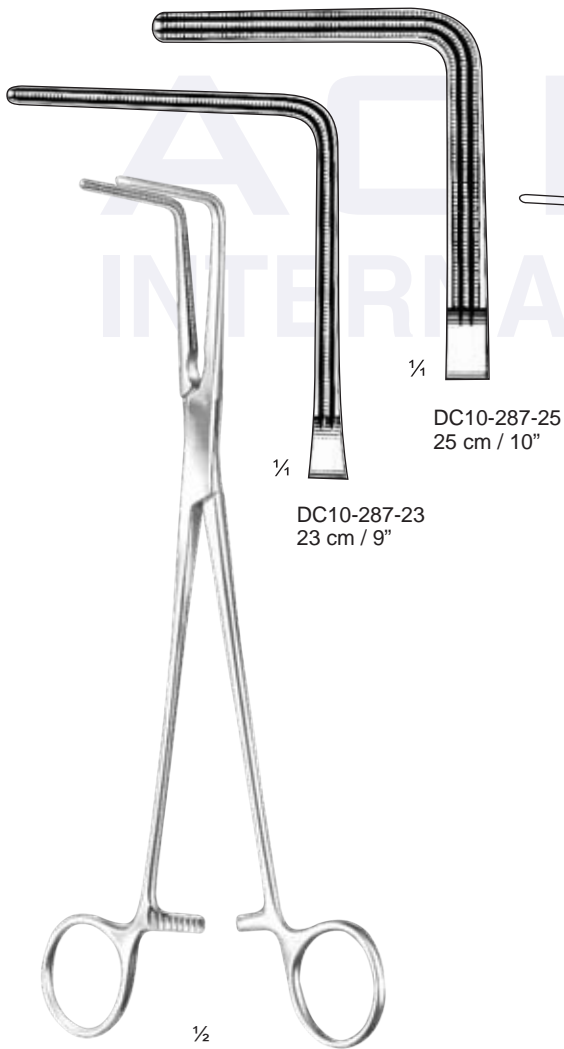
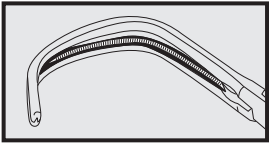

**Lees**  
DC10-287-23 - DC10-287-25

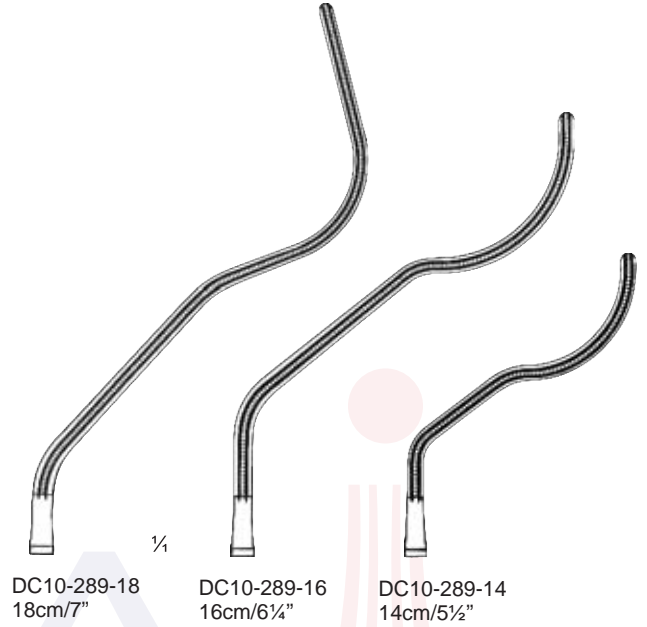

DC10-289-18  
18cm/7"

DC10-289-16  
16cm/6 1/4"

DC10-289-14  
14cm/5 1/2"

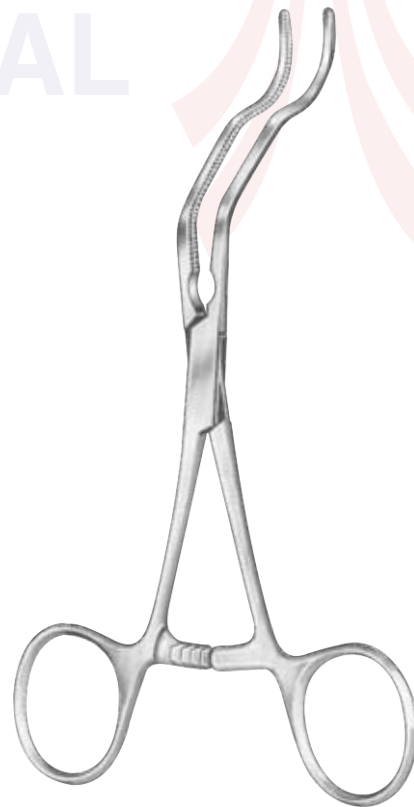

**Gregory**

Blood Vessel Forceps & Clamps

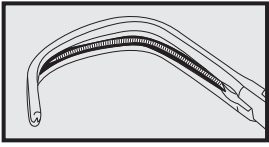

**Wylie "J"**

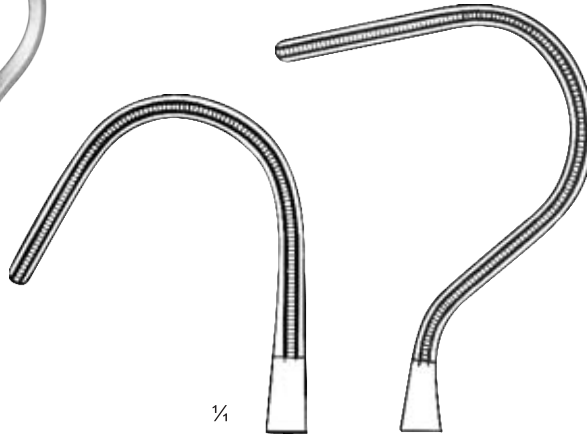

¼  
DC10-291-21  
21cm/8¼"

¼  
DC10-291-22  
22cm/8¾"



½  
**Lees**  
DC10-293-25  
25 cm /10"

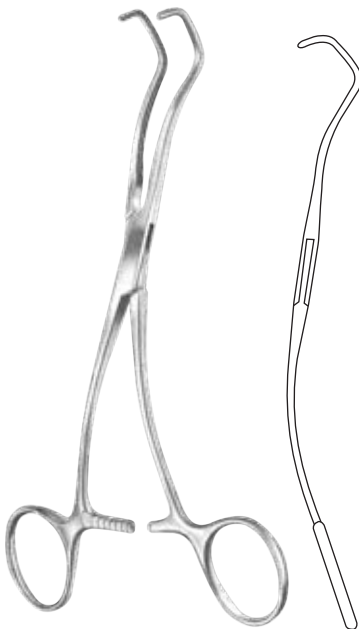

**Derra**  
DC10-295-16 - DC10-295-18



¼  
DC10-295-16  
16 cm /6 ¼"



¼  
DC10-295-17  
17 cm /6 ¾"



¼  
DC10-295-18  
18 cm /7"



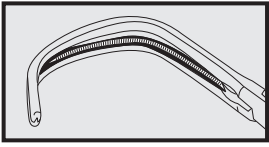

Blood Vessel Forceps & Clamps



**Cooley**  
DC10-303-16 = 16 cm / 6 1/4"  
DC10-303-17 = 17 cm / 6 3/4"

1/4 DC10-303-17  
DC10-303-16

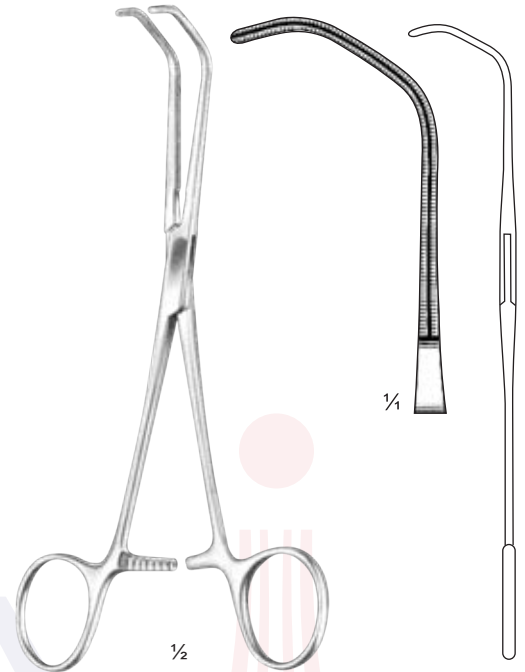

**Beck**  
DC10-305-17  
17 cm / 6 3/4"

1/2

1/4

ACMA  
INTERNATIONAL

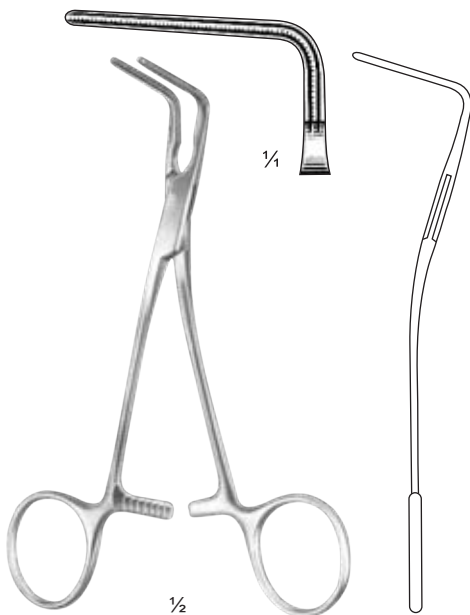

**DeBakey**  
DC10-307-15  
15 cm / 6"

1/4

1/2

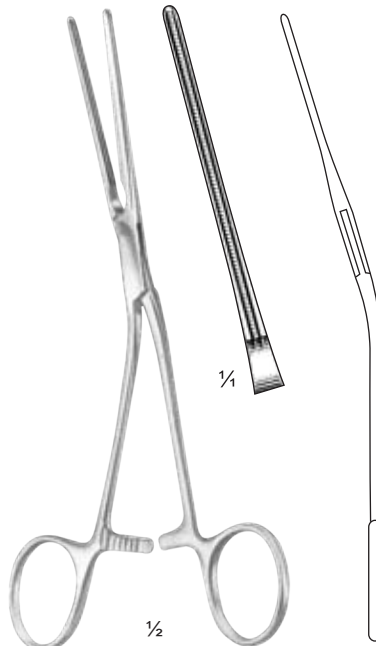

**DeBakey**  
DC10-309-17  
17 cm / 6 1/4"

1/4

1/2

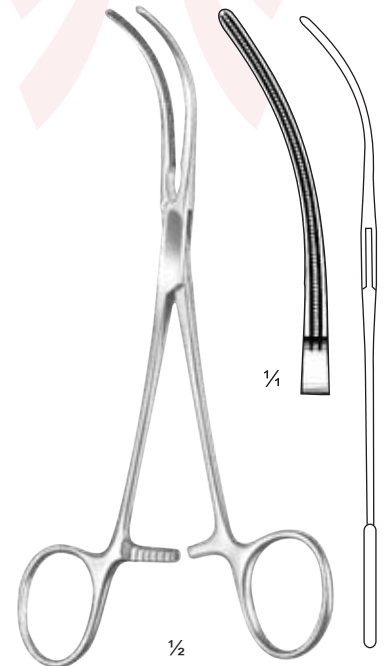

**Glover**  
DC10-311-17  
17 cm / 6 3/4"

1/4

1/2

Blood Vessel Forceps & Clamps

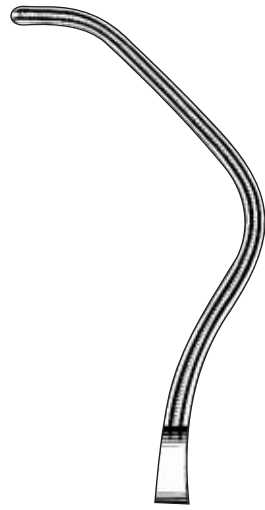
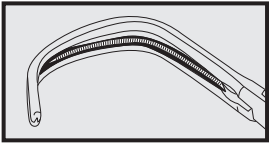

DC10-313-03  
24 cm/9 1/2"



1/4  
DC10-313-04  
24 cm/9 1/2"

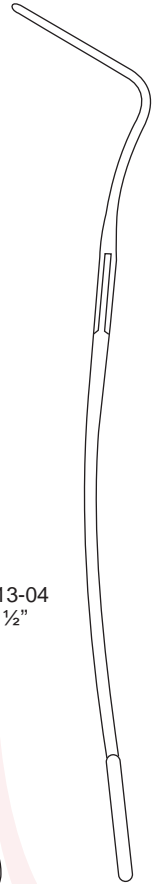

1/4  
DC10-313-01  
24 cm/9 1/2"



1/4  
DC10-313-02  
24 cm/9 1/2"



Harken  
DC10-313-01 - DC10-313-04

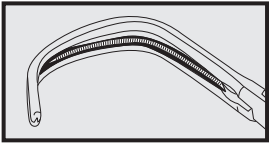

**Cooley-Derra**  
DC10-315-16 - DC10-315-18



DC10-317-21 - DC10-317-31

¼  
DC10-315-16  
16 cm / 6 ¼"

¼  
DC10-315-17  
17 cm / 6 ¾"

¼  
DC10-315-18  
18 cm / 7"



¼  
DC10-317-21  
21.5 cm / 8 ½"

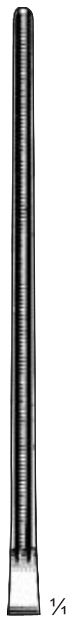

¼  
DC10-317-23  
23 cm / 9"



¼  
DC10-317-27  
27 cm / 10 ½"



¼  
DC10-317-31  
31.5 cm / 12 ½"

Blood Vessel Forceps & Clamps

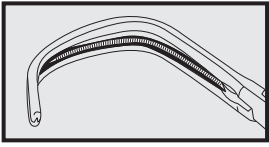

DC10-331-21 - DC10-331-31



DC10-331-21  
21.5 cm / 8 1/2"



DC10-331-23  
23 cm / 9"



DC10-331-27  
27 cm / 10 1/2"

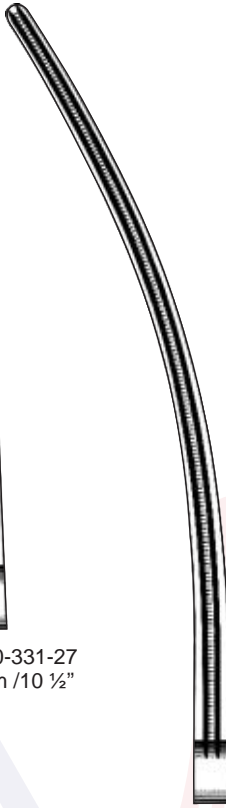

DC10-331-31  
31 cm / 12 1/2"



DC10-333-26 - DC10-333-33



DC10-333-26  
26 cm / 10 1/4"



DC10-333-27  
27 cm / 10 1/2"



DC10-333-31  
31 cm / 12 1/4"



DC10-333-33  
33 cm / 13"

